

Operating Instructions



4CH 1080P MDVR (SATA SSD & SD card)

Thank you for using our DVR. Please read this User's Manual carefully to ensure that you can use the device correctly and safely.

The contents of this manual are subject to change without notice.

V1.1

Contents

1 Specifications.....	1
2 Precautions.....	3
3 Main Features.....	4
4 Wiring Diagram.....	6
5 Connection - Front Panel.....	7
5.1 LED.....	7
5.2 Electronic Lock.....	7
5.3 Remote Controller.....	8
5.4 SSD Slot.....	8
5.5 SD Card Slot.....	9
5.6 USB Slot.....	9
6 Back Panel.....	9
6.1 Power.....	10
6.2 Cameras (AVIN 1~4).....	10
6.3 LCD Monitor.....	11
6.4 Buzzer.....	12
6.5 Recording Files Output.....	13
6.6 Alarm Interface.....	13
6.7 Panic Button and Its Conversion Cable (Optional).....	15
6.8 Four-in-one Antenna (GPS, 2G/3G/4G, Wi-Fi).....	18
7 The Menu.....	18
7.1 Menu Introduction.....	18
7.2 Menu Lock.....	20
7.3 Keyboard Operation Instruction.....	22
7.4 Manual Recording.....	24
7.5 Playback.....	25
7.6 Log.....	29
7.7 Display Mode Switching.....	29
7.8 System.....	30
7.9 Disk.....	30

7.10 Volume.....	32
8 Record Setup.....	32
8.1 Power On Rec.....	32
8.2 Cyclic Rec.....	32
8.3 Event Rec.....	33
8.4 Video Quality.....	34
8.5 Record Channel.....	36
8.6 Event Duration.....	36
8.7 File Length.....	36
8.8 Motion Sensitivity.....	37
8.9 G-force Sensitivity.....	37
8.10 File Type.....	44
8.11 Record Audio.....	44
9 Display.....	44
9.1 Camera Display Setting.....	45
9.2 Camera Name Setting.....	45
9.3 System Language Setting.....	46
9.4 Audio Out.....	46
9.5 OSD Display Setting.....	47
9.6 Menu on.....	47
9.7 Speed.....	48
9.8 GPS.....	49
9.9 Mirror.....	49
9.10 System Format Setting.....	50
10 Network.....	51
10.1 LAN and Server Setting.....	52
10.2 Wi-Fi Network Setup and Server Setup.....	53
10.3 2G/3G/4G Control and Setup.....	55
10.4 AP Internet Setup.....	57
10.5 Network Status.....	57
10.6 Server.....	58
10.7 File Upload.....	59
11 System.....	61

11.1 Log in Setup.....	61
11.2 License Plate Number Setup.....	62
11.3 System Time Setup.....	62
11.4 Scheduled Recording.....	64
11.5 Exception.....	65
11.6 ACC Settings.....	66
11.7 Alarm Information Setting.....	67
11.8 Update.....	70
11.9 Configuration.....	73
11.10 System Info.....	74
12 FAQ.....	75
13 APPENDIX.....	76
APPENDIX I : Abbreviation & Description.....	76
APPENDIX II: Accessories.....	77
APPENDIX III: Compatibility Storage List.....	78

1 Specifications

4CH HD DVR		
System	Operating system	Linux
	Operating interface	Graphical menu operation interface(OSD)
	Video permission	Administrator & user setting
Video	Video input	4 x 1080P analog high definition
	CVBS output	1CH 6pin aviation connector output PAL/NSTC
	VGA output	1CH VGA output, 1080P
	Video display	1, 2, 3, 4
	Video standard	PAL: 25fps, NTSC: 30fps
	Compression	H.264 main profile
Audio	Audio input	4 channels
	Audio output	2 channels
	Record format	Synchronized video & audio recording
	Audio compression	ADPCM
Digital processing & storage	Image resolution	Max 4 x 1080P (1920 x 1080)
	Video bit rate	64kbps~4Mbps/channel
	Storage	56~2700MB/ (channel x hour)
	Audio bit rate	32kbps
	Storage	2.5 inch SATA SSD x 1, max 2TB; SD card x 1, max 128GB
Alarm	Alarm input	6 channels
	Alarm output	2 channels
	Motion detection	High/low/off sensitivity adjustable
Interface for communication	IR	1 channel
	RS232	1 channel
	RS485	1 channel
	CAN	2 channels
	RJ45	1 channel
	USB2.0	2 channels 1 channel for copying file (SSD/ SD) and firmware upgrade 1 channel for copying SSD file (only for connecting to computer USB)
Wireless	2G/3G/4G	Optional
	Wi-Fi	Optional
	Wi-Fi hot spot/AP	Optional
GPS	Optional	
G-Force /Gyroscope	Nine axis sensor	Available

Software	Windows client	Available
	iOS client	Available
	Web portal	Available
Power	Input	10~32V
	Output	12V@3.5A
	Max Power Consumption	60W
	Standby Power Consumption	100mW
Electrical spec	Operating temp. & humidity	-20~+70°C, RH100% Max.
	Super Capacitor	Available
	Clock	Built-in clock, Calendar

2 Precautions

- 1) Motion detection function is set to OFF by default. Alarm files will be created When the motion detection is set ON.
- 2) G-Force recording is recommended to set ON during driving for emergency recording use. G-Force level is optional.
- 3) If the device could not boot up, try to remove all storage disks from the device, and then restart it to check whether it could boot normally or not.
- 4) Should: ACC wire should be connected to the ignition wire, two VCC wires to the positive pole of the battery and two ground wires to the negative pole. Shouldn't: ACC and two VCC wires should not be connected to the ignition wire and two ground wires should not be connected to the negative pole of the battery, otherwise it may lead to the damage of the disk and the recording files. Prohibit: ACC and two VCC wires are prohibited to be connected to the positive pole of the battery and two ground wires to the negative pole. In this case, the battery would be run out quickly.
- 5) All the disks must be formatted on the device before they are put into use.
- 6) The users' name could not be changed, while the password is editable.
- 7) All types of video files including event recording files are overwritten by default. If the user does not want to overwrite the event files, please set [Event Rec. Lock] to ON which could be found in the menu of [Event Rec.].
- 8) The corresponding types of sensors are as following:

SENSOR- IN1	SENSOR- IN2	SENSOR- IN3	SENSOR- IN4	SENSOR- IN5	SENSOR- IN6
ALARM INPUT 1~4				Reverse input	Brake input

- 9) The disk must be installed appropriately and well connected; otherwise the device would not work properly.
- 10) GPS antenna, 2G/3G/4G antenna, Wi-Fi antenna must be connected correctly and tighten.

3 Main Features

Appearance

- Compact size and waterproof.

Controlled by touch screen

- All settings and operations could be done through a touch-control monitor.

Video and Audio

- 4 channels x 1080P.
- 4 video inputs with audio.
- 2 video output with audio.
- 1 CVBS output (1 x 6 PIN OUT), 1 x VGA (1080P).

Recording

- 4CH Video & Audio Recorder with image resolution up to 1920 x 1080, G-force data and GPS data.
- Multiple recording modes: power on recording, manual recording, schedule recording and event recording (i.e., G-force recording, over-speed recording, motion detection recording, alarm recording 1~6, panic button recording, radar detection alarm recording, inappropriate drivers' action warning recording, driving safety risk recording), Cyclic recording and 10 seconds pre-recording are also supported.
- Recording files are stored in the SSD or SD card.
- Real-time recording of license plate numbers, driving speed, G-force/Gyroscope 6D accelerated speed, longitude and latitude, and GPS tracking.

Preview and Playback

- Support single channel or 4 channels audio and video playing back simultaneously.
- Support searching recording files by dates and recording types.
- Support to control the time during playing back.
- Indicating recording status, alarm status and etc.

Storage Types

- Support 1 x SSD (2TB) and 1 x SD card (128GB, SDHC, SDXC).
- SSD is preferred. SD card could be put into use if there is no SSD connected/detected.
- A computer could be connected and read the SSD through the SSD-out cable.

Backup

- Support USB disk or USB hard disk to backup the recording files.

Network

- Support LAN, Wi-Fi, and 2G / 3G / 4G.
- LAN, Wi-Fi and 2G / 3G / 4G have the sequence priority of connections. They are automatically switched to save the data once LAN or Wi-Fi is connected.
- Recording files could be uploaded to the server by FTP. Files are able to be searched/downloaded by CMS Client.
- Wi-Fi supports STATION and AP mode. Wi-Fi AP mode enables mobile devices to be connected, and users could use mobile devices to preview and configure conveniently.
- Support remote real-time video streaming and previewing.
- Support automatic uploading of alarm recording files, alarm information, log information and GPS tracking route, which is convenient to analyze any abnormal conditions of vehicles and track the vehicle.
- Support remote configuration and remote upgrading.
- Support web portal, PC Windows Client, IOS and Android app. Management could remotely monitor vehicles by computers or mobile phones.

Alarm

- 6 channels of alarm inputs, 1 channel of buzzer output and 2 channels of alarm outputs
- Over-speed alarm
- Motion detection alarm
- G-force alarm
- Panic button alarm

Security

- Users' password protection. The device could not be accessed without password.
- Support account management.

4 Wiring Diagram

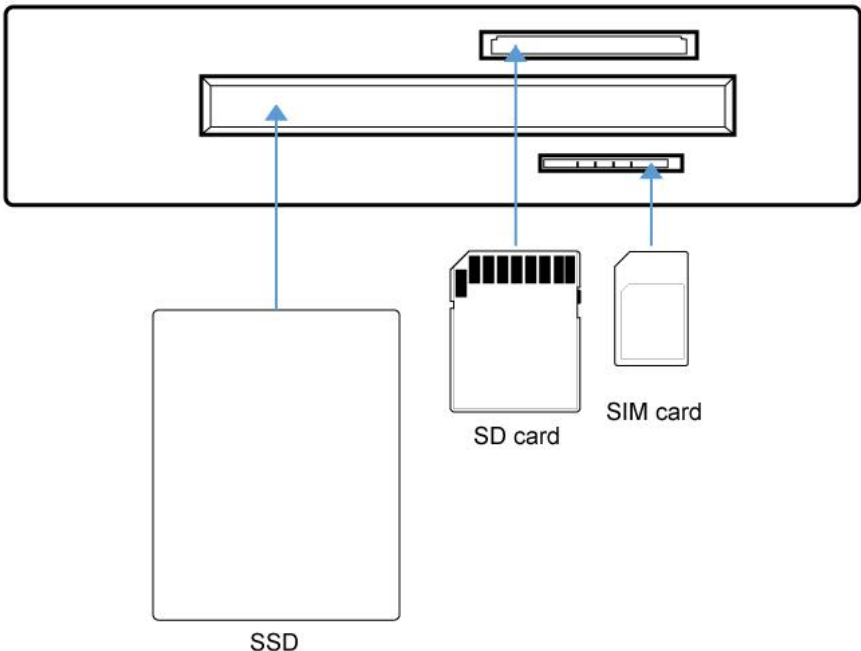
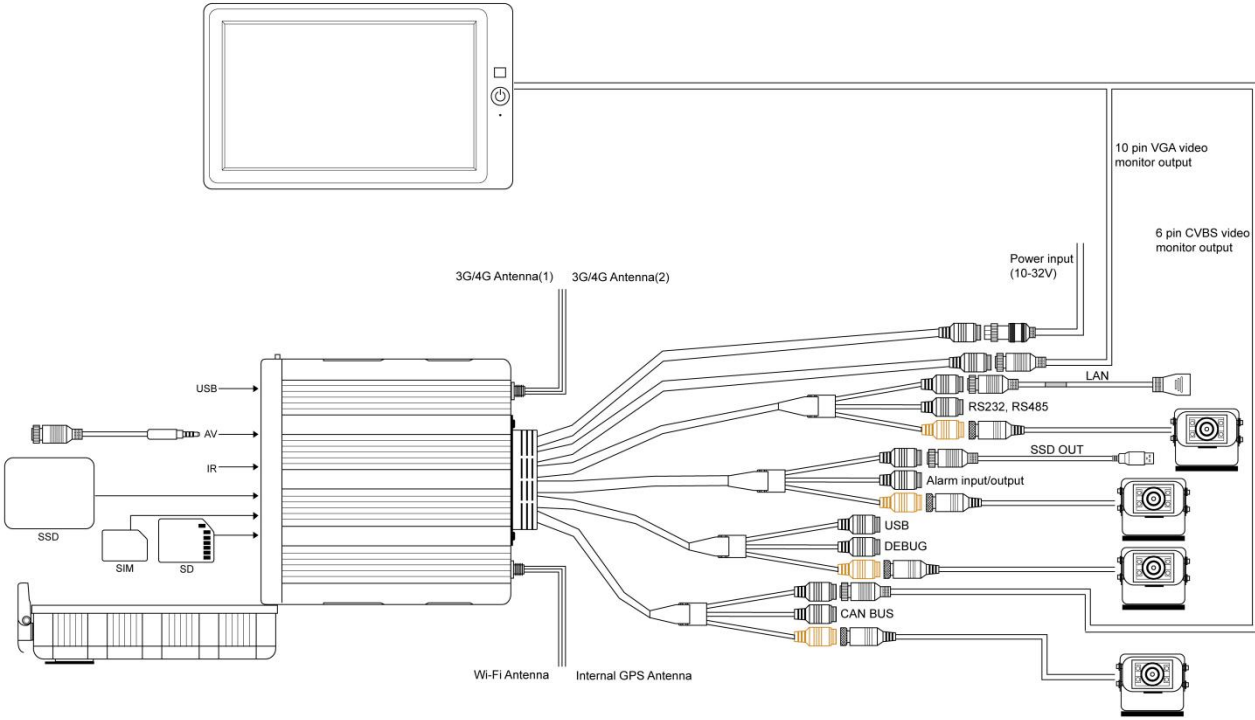

5 Connection - Front Panel

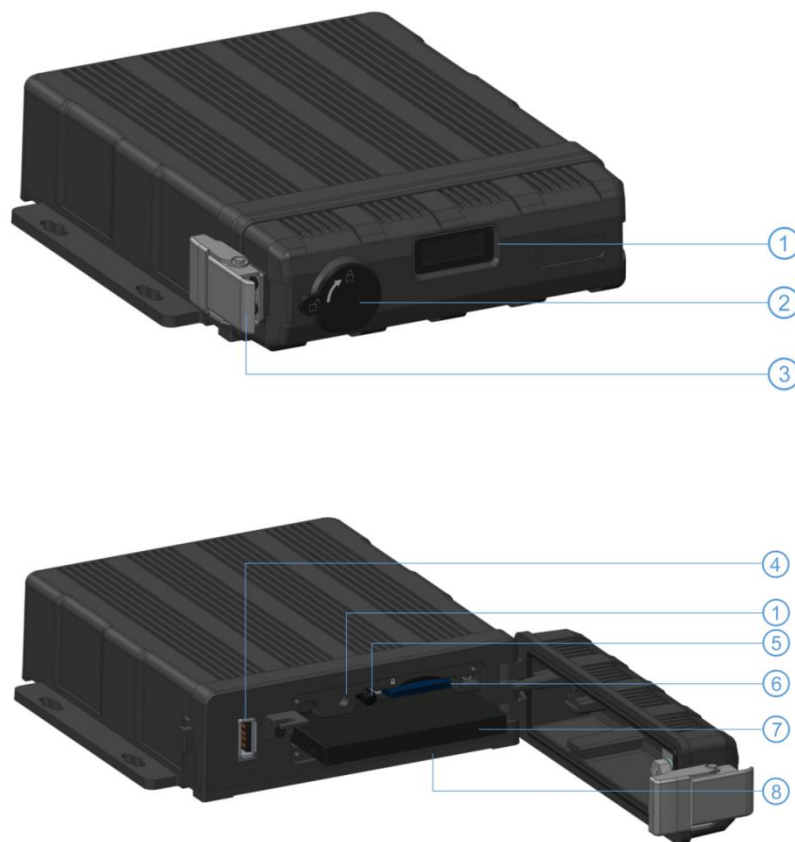

- ① LED Indicators
- ② Electronic lock
- ③ Front Cover Buckle
- ④ USB2.0 port

- ⑤ IR Receiver
- ⑥ SD Card Slot
- ⑦ SSD Slot
- ⑧ SIM Card Slot

5.1 LED

The red light is on constantly while the green light flickers when the device is working properly.
The red light is on constantly while the green light is off when the device is upgrading the system.













5.2 Electronic Lock

- Close the front cover, lock the buckle, and then lock the device with the key.
- The device will stop recording and the buzzer will beep when the front cover is open or the lock is unlocked.

5.3 Remote Controller

Use the remote controller closer enough to the IR Receiver, otherwise it may not work.



DESCRIPTION	KEY	
Not in use	POWER	
Switch the screen to channel 1~ 4 for live view.	1~4	
Switch to default display	0	
Call up main menu	MENU	
Upward for MENU selection	Up	
Towards to left for MENU selection or Menu setup	Left	
Enter the sub-menu to set and confirm	ENTER	
Manual recording button	REC	
Downward for MENU selection	Down	
Exit	ESC	
Towards to right MENU selection or MENU setup	Right	
Switch to display mode	MULTI	
Clear the input info	CLEAR	

5.4 SSD Slot

- 1 x SSD (Max. 2TB)
- Size: 2.5 inches (70 x 100 x 7mm)
- A computer could be connected and read the SSD through the SSD-out cable

5.5 SD Card Slot

- 1x SD (Max. 128GB)
- Insert, remove the SD card.

Step 1: Use the key to unlock the device and open front cover.

Step 2: Insert SD card to SD card slot.

Step 3: Close the front cover and use the key to lock.

5.6 USB Slot

USB 2.0

6 Back Panel

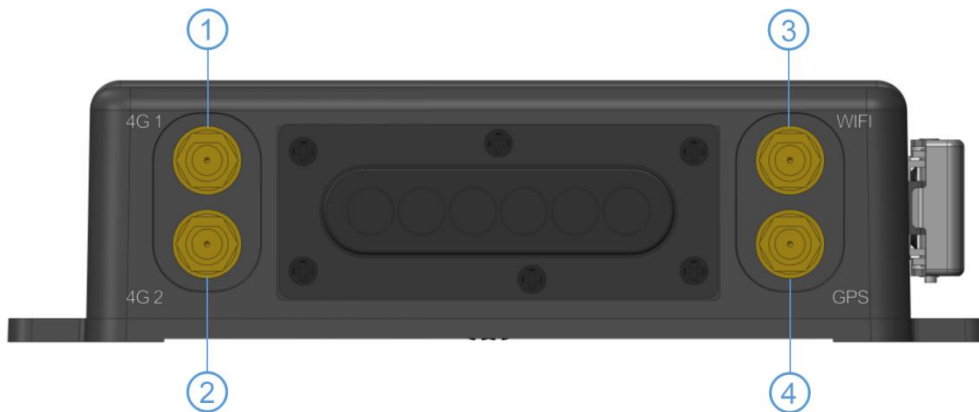

- | | |
|------------------------------------|-------------------|
| ① Cellular Connector, TX/RX | ③ Wi-Fi Connector |
| ② Cellular Diversity Connector, Rx | ④ GPS Connector |

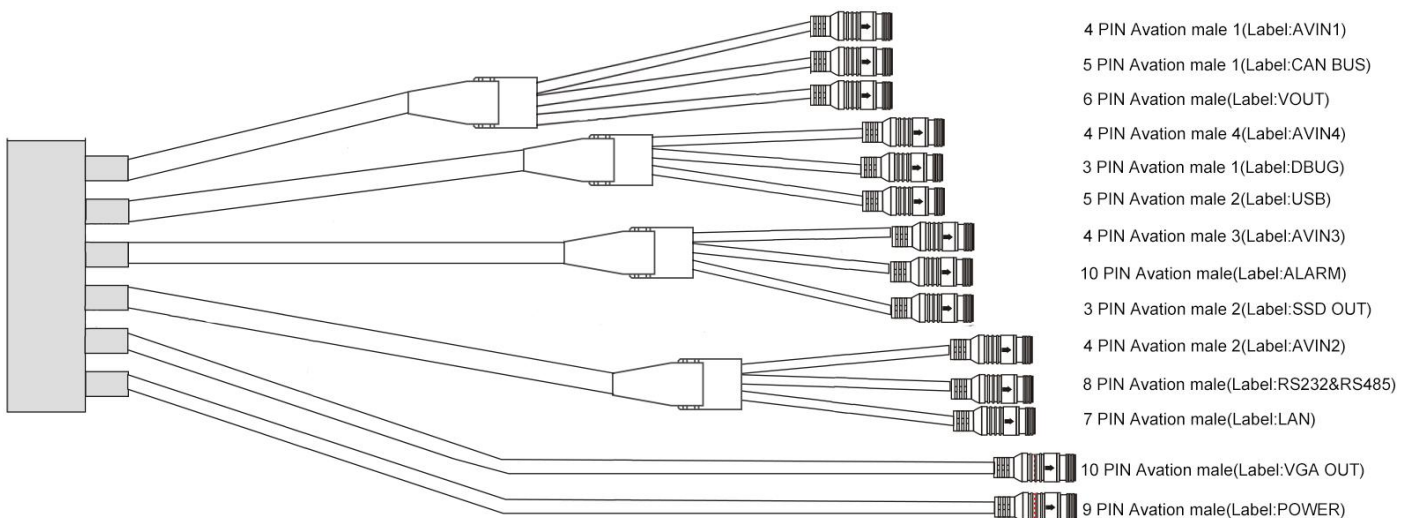

6.1 Power

- power input

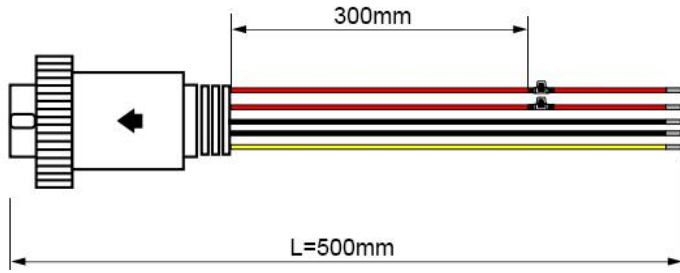

Connect the 9 PIN female to the 9 PIN male on the device.

- Connection

Connect ignition wire to yellow ACC, battery Positive to V+(Red wire) and Negative to GND (black wire).

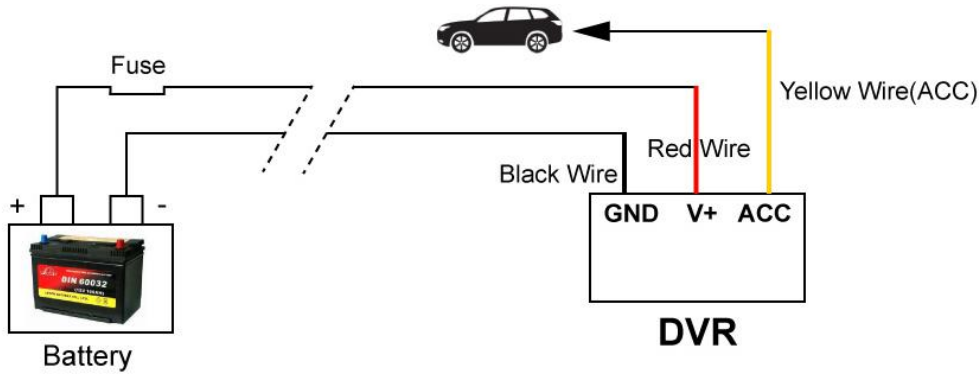

6.2 Cameras (AVIN 1~4)

- Below is the definition of camera input (male).

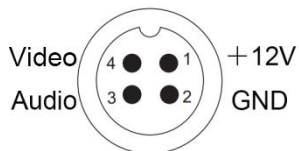

- How to connect cameras

Connect cameras to the device at the back panel via 4pin connections.



Connect No.1 camera to AVIN1 4PIN Aviation male.

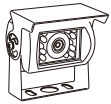

Connect No.2 camera to AVIN2 4PIN Aviation male.

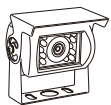

Connect No.3 camera to AVIN3 4PIN Aviation male.



Connect No.4 camera to AVIN4 4PIN Aviation male.

6.3 LCD Monitor

- High definition monitors are recommended to work with the device as below:



- Output resolution of the LCD monitor can be selected. Settings are as follows:

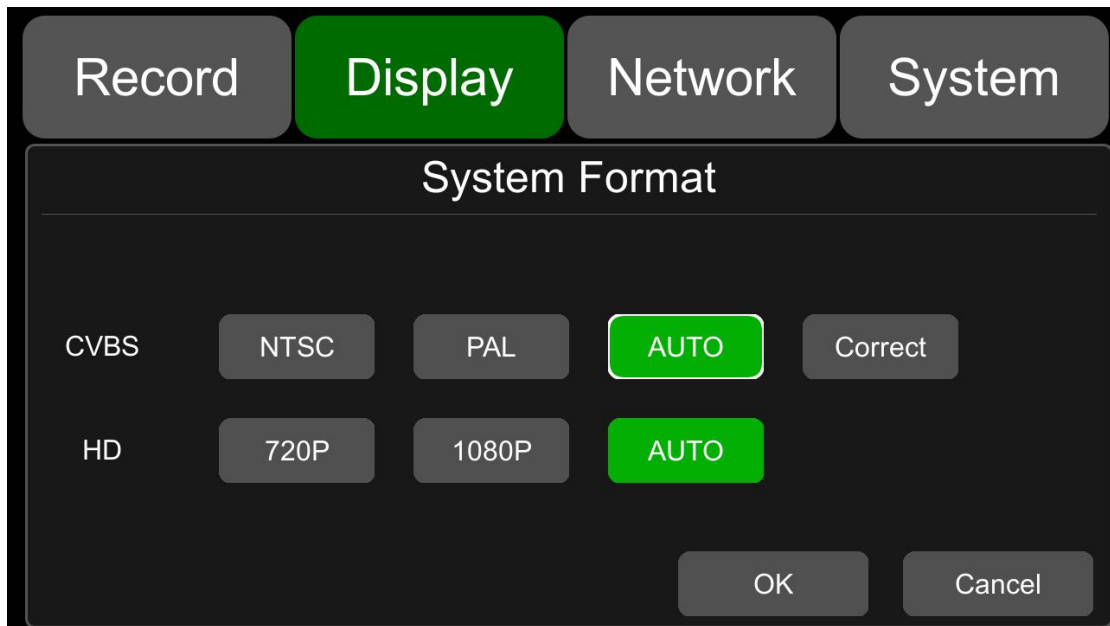

AUTO supports as below:

System Format		
	CVBS	HD
AUTO	NTSC/PAL	1080P/720P

6.4 Buzzer

If the device is not connected to a monitor, please check the recording status by the buzzer.

The buzzer would alarm if the device is not recording under Normal Mode which is set by default. To stop the buzzer from alarming, please make sure the device is working properly.

The buzzer warning function is as follows:

The buzzer will keep beeping for a while for all types of alarm event recording.

If the buzzer alarm is not needed, users can go to “System - Exception” page, and set Buzzer to OFF.

And please note that if the Buzzer is set to be OFF, there would be no alarm even if any event is triggered.

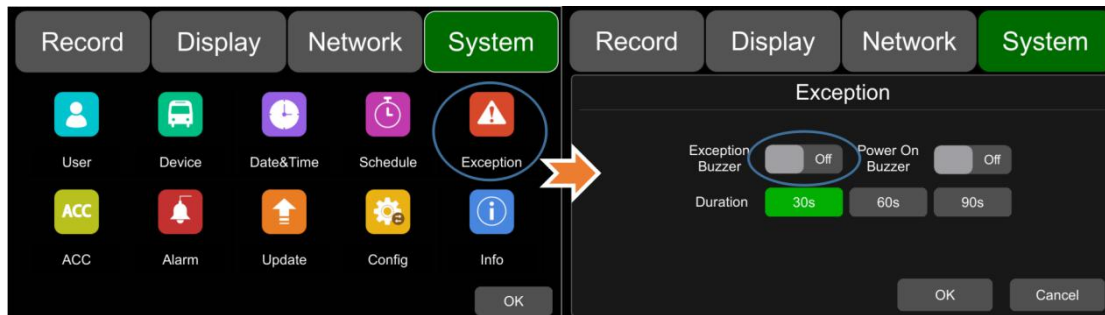

If the buzzer beeps intermittently, it means that the device is unable to record.

Different beeping modes stand for different working status as below:

- 1) The electronic lock is open: one long beep and one short beep.
- 2) No disk: one long beep and two short beeps.
- 3) Abnormal disk system: one long beep and three short beeps.
- 4) If the disk is operating normally, the video file is full, and the Cyclic Rec. is off: two short beeps and one short beep.
- 5) No camera input: two short beeps , and two short beeps after a second.
- 6) If the disk is well connected but the device is not in recording: two short beeps and three short beeps.

6.5 Recording Files Output

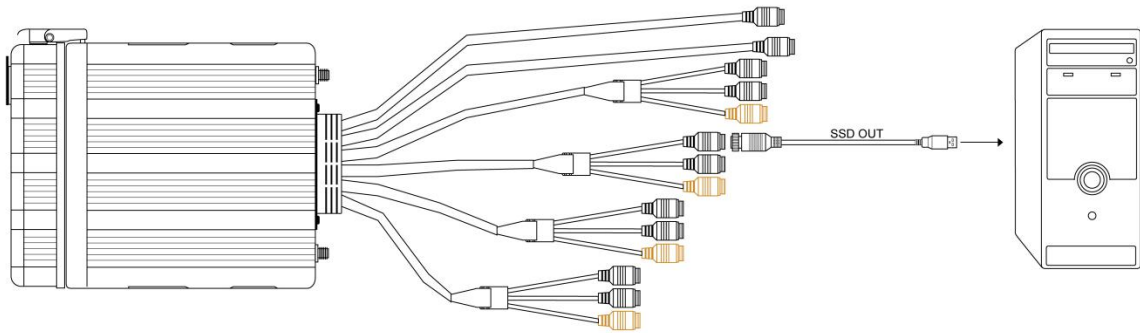

Connect the 3 PIN female of cable “SSD OUT” to the 3 PIN male on the device

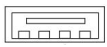

Connect the device to a computer by USB

A computer could be connected to the device and read the SSD through the SSD-out cable, which enables the users to read the disk without taking it out.

6.6 Alarm Interface

- Alarm interface cable

See the picture below.

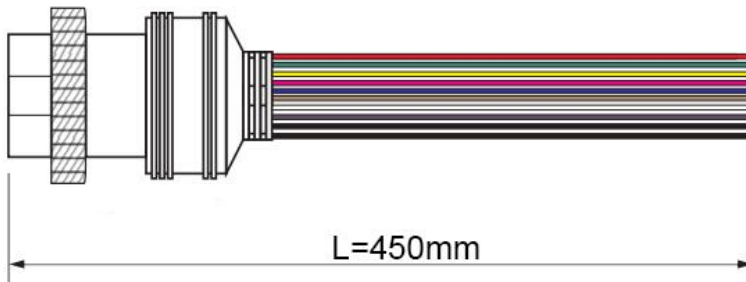

- Pin Definition:

10 PIN	1	2	3	4	5	6	7	8	9	10
Colour	red	pink	blue	gray	white	purple	green	yellow	black	black
Definition	Alarm out2	Alarm out1	Alarm_in 6	Alarm_in 5	Alarm_in 4	Alarm_in 3	Alarm_in 2	Alarm_in 1	GND	GND

1) Below is the alarm setting. Alarm1, Alarm2, Alarm3 and Alarm4 could be renamed by users.

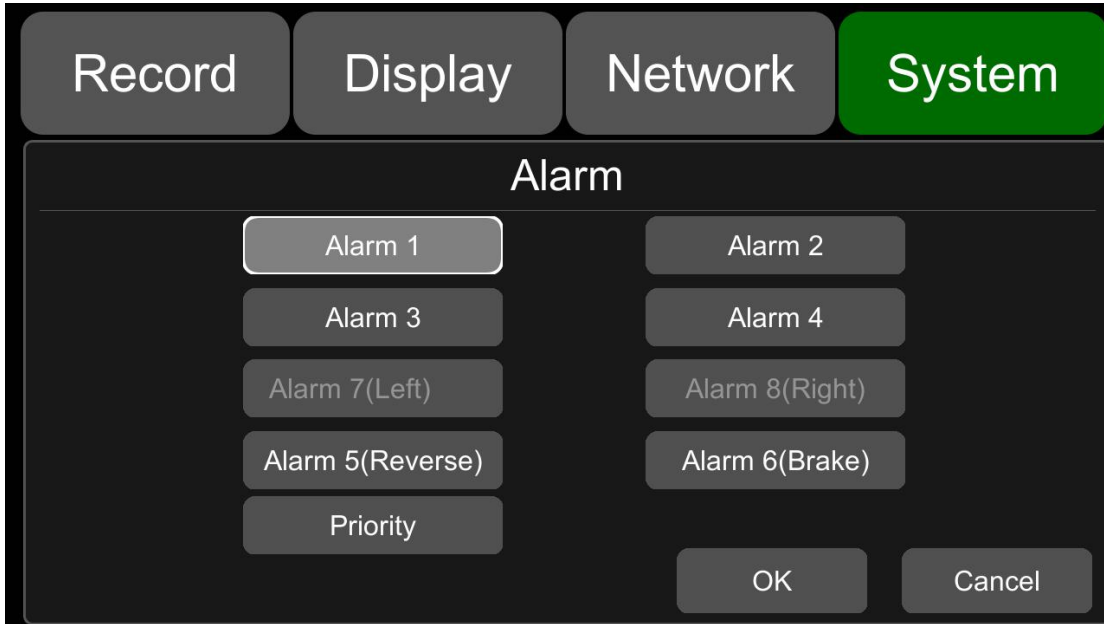

2) Alarm output 1 and alarm output 2 are 12V by default, which can be used as a trigger and working together with alarm inputs. You can also set up the BUZZER as one output.

3) If Alarm input 1 is active and combined with Alarm output 1, the Alarm output 1 will output a high-level voltage to trigger other device.

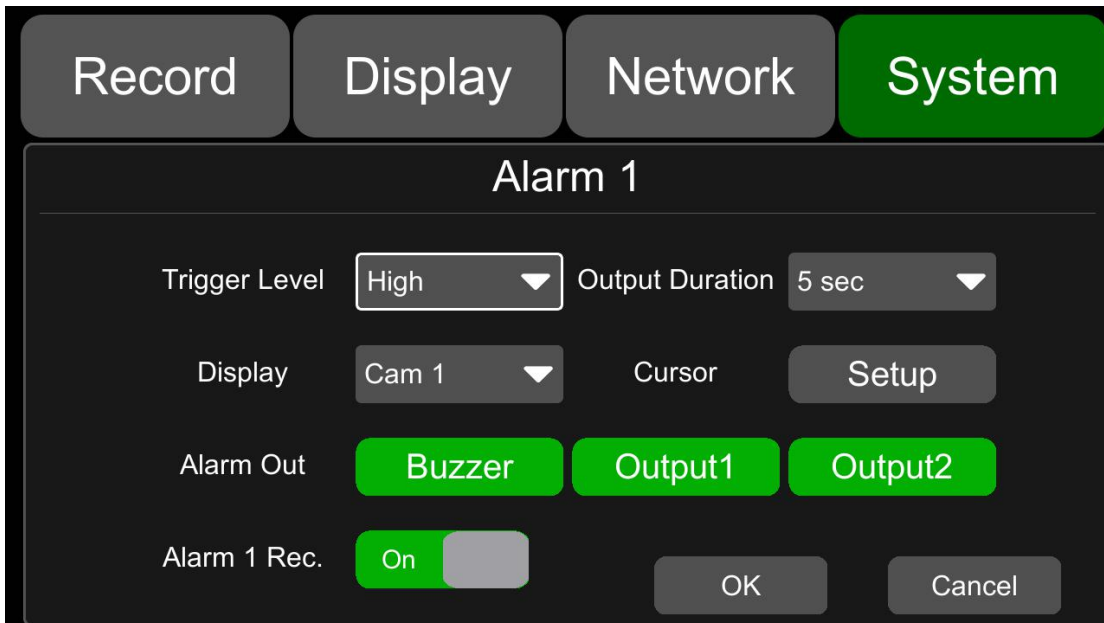

6.7 Panic Button and Its Conversion Cable (Optional)

- Overview

The LEDs are used to show the working status of the device. But when the device is installed in the vehicle, it is not easy to check the LED on the front panel. Each LED indicates the corresponding status of the device. Furthermore, the panic button makes it easier to trigger alarm and recording for emergency by pushing a single button.

The panic button has four main features including LED indicators, emergency button, buzzer alarm and infrared function.



- Pin Definition

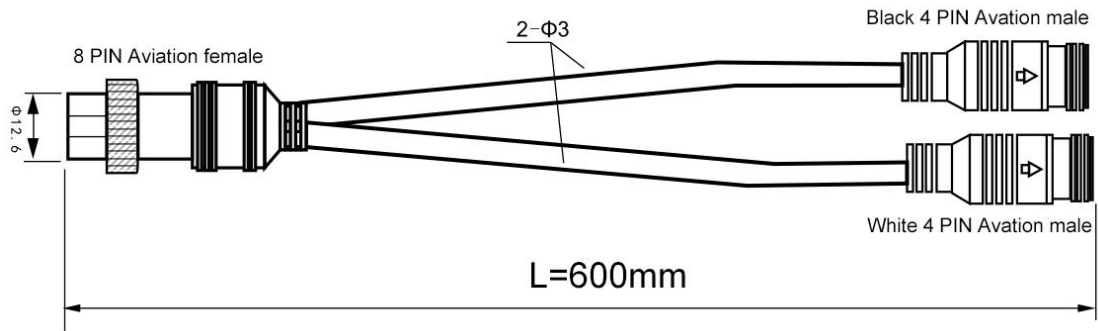

Connect the 8 PIN female of above cable to the 8 PIN male (RS232&RS485) on the device.

- LED

LED	Color	ON	OFF
VLoss	Amber	Go to [Setting]-[Record]-[Record Channel] to see if any camera is missing. In case any camera is chosen but not connected, LED would show yellow	Normal operation
Rec	Soft green	Starts to record	No recording
GPS	Amber	GPS signal is lost	Normal operation
Mem	Red	Storage damage or NO storage	Normal operation
Comm	Amber	Device is not connected to the server	Normal operation or device is not connected to the server if this feature is disabled
Power	Pale Blue	Power is connected	NO power
Error	Red	Error with device	Normal operation
Event	Red	Starts event recording	Normal operation

- Panic Button

Panic Button is labeled as “Bookmark”.

- 1) When the bookmark button is pressed, an emergency event will be triggered.
- 2) When the bookmark button is pressed, the Event LED light will work temporarily.

If the panic button alarm recording cannot be triggered, please check if the Event Rec. is set ON as shown below:

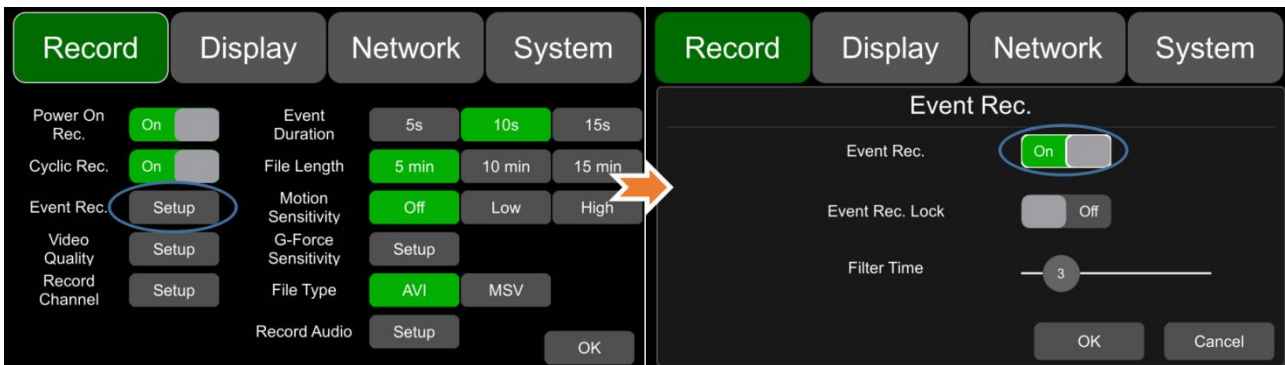

If the alarm recording is triggered, there will be an alarm sign on the screen, as shown below:

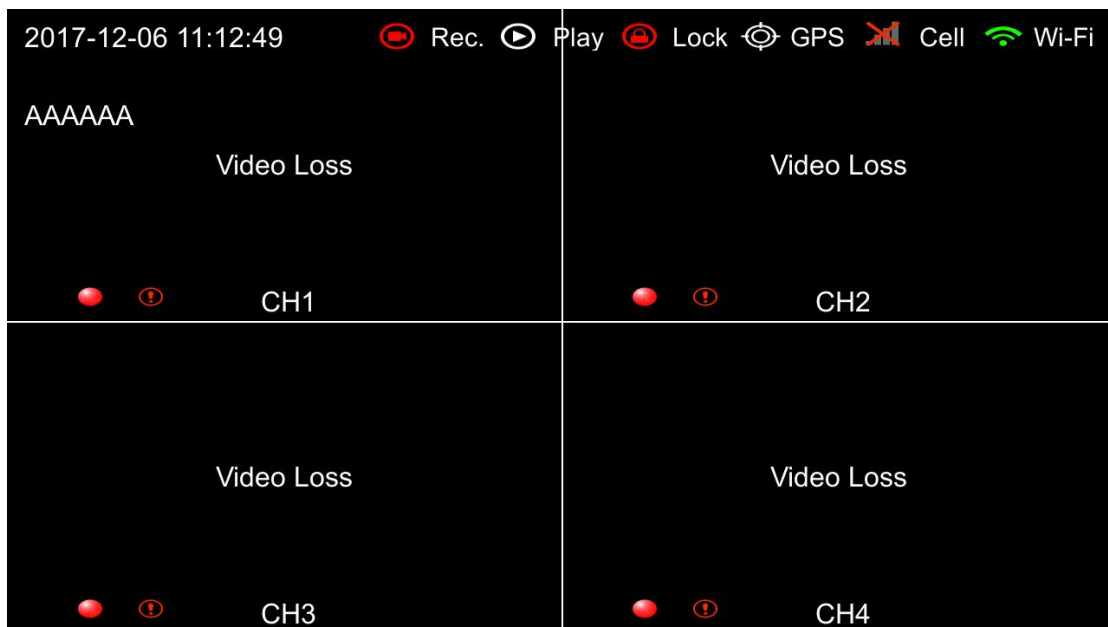

- IR receiver

When the remote control aims to the IR on panic button, it has the same effect of aiming to that on the device. Sometimes the recorder will be installed in a relatively hidden place in the vehicle, which is not possible for users to directly control the device by remote control. So it will be more convenient for users to operate with the panic button.

- The buzzer

The alarm from the buzzer in panic button is convenient for checking the status of the device.

When the Power On Buzzer is set ON in the menu System->Exception, the buzzer will alarm for 4 seconds once the device is powered up. When the Power On Buzzer is set OFF, the buzzer will not alarm once the device is powered up.

When the Buzzer is set ON in the menu System->Exception->Exception Buzzer, the buzzer will continuously alarm when the alarm is triggered.

When the Buzzer is set OFF in the menu System->Exception->Exception Buzzer, the buzzer will not continuously alarm when the alarm is triggered.

6.8 Four-in-one Antenna (GPS, 2G/3G/4G, Wi-Fi)



7 The Menu

7.1 Menu Introduction

Press [MENU] on the remote control or touch the bottom area on a connected LCD screen, the Menu will be shown as below. Please log in before entering the menu.

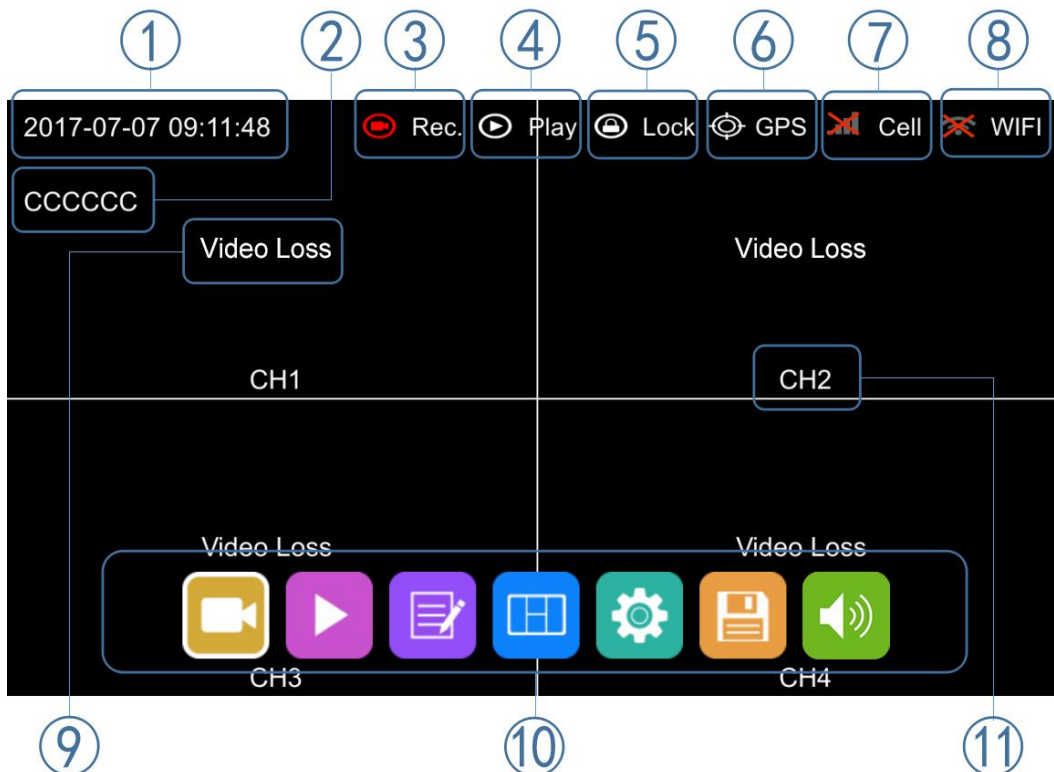

- ① System time display
- ② License plate number display
- ③ Recording status

The recording sign will turn red when recording starts.

- ④ Playback

The playback icon will turn red during playing back.

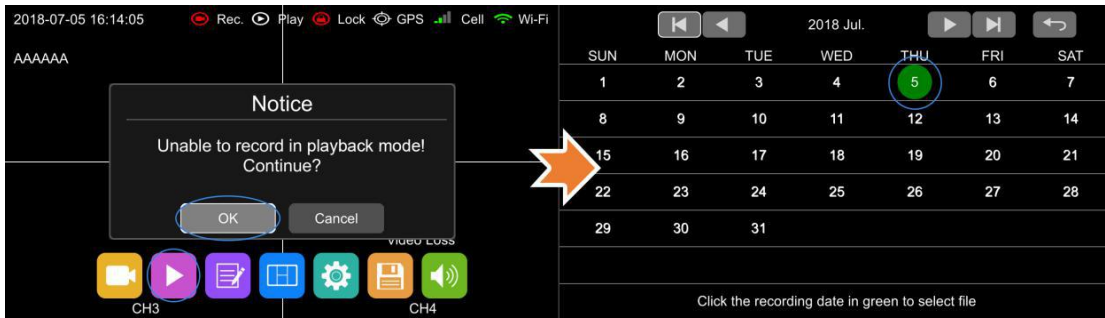

- ⑤ Electronic lock

- Lock indicator turns red when it is locked and the front cover is closed.
- Electronic lock is different from menu lock.

- ⑥ GPS status

The GPS icon will be flashing when connecting. It will be always ON if it is successfully connected.

- ⑦ Cell status

- ⑧ Wi-Fi status

- ⑨ Video Loss

- ⑩ Menu

Press [Area 10] to display MENU options.

- ⑪ Channel name

7.2 Menu Lock

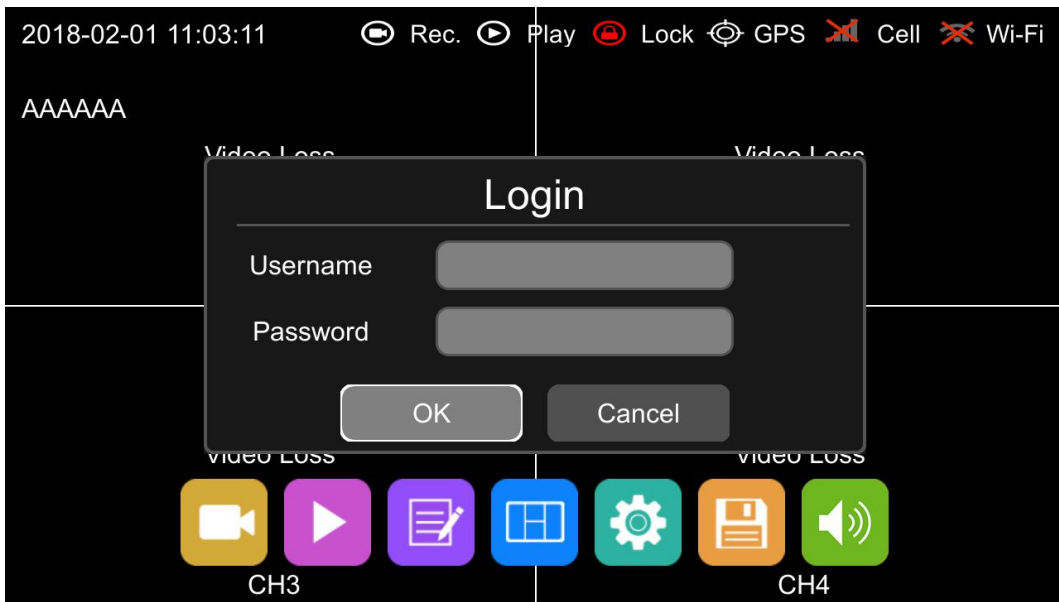

- The device/recorder supports two kinds of permissions: admin permission and guest permission.
- Users' account list

	Admin Permission	Guest Permission
User Name	admin	guest
Password Modification	yes	no
Initial Password	88888888	88888888
Permission	Enter all menus	Enter the menu of Playback, Display mode switching and Volume

- Users' name could not be changed, but users' password is changeable. Guest does not have permission to enter the setup menu, so the password cannot be changed. See the following instructions to change the password.)

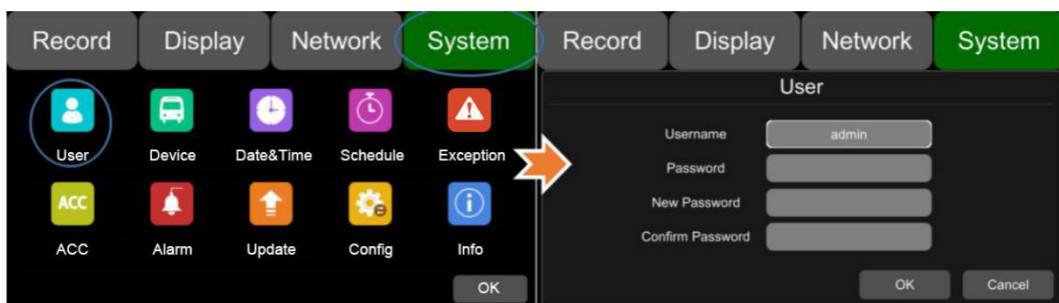

- Only the administrator could change the status of Menu lock. The following picture shows how to change the Menu Lock status from ON to OFF.

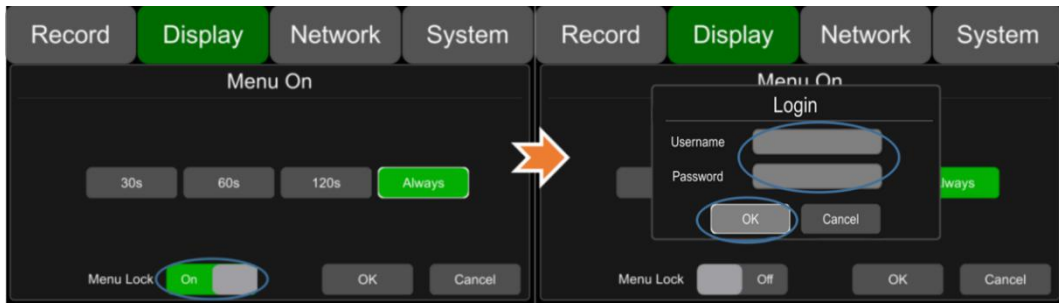

- When the menu lock status is "ON", you need to enter the user name "admin" and password to enter the "recording", "play", "log", "settings", "disk" "layer switching" and "volume adjustment" and other menus. If you use the user name "guest" and password, you can only enter the "play", "layer switching" and "volume adjustment" menu. When the menu lock status is "Off", you do not need to enter the user name and password to enter the menu.



7.3 Keyboard Operation Instruction

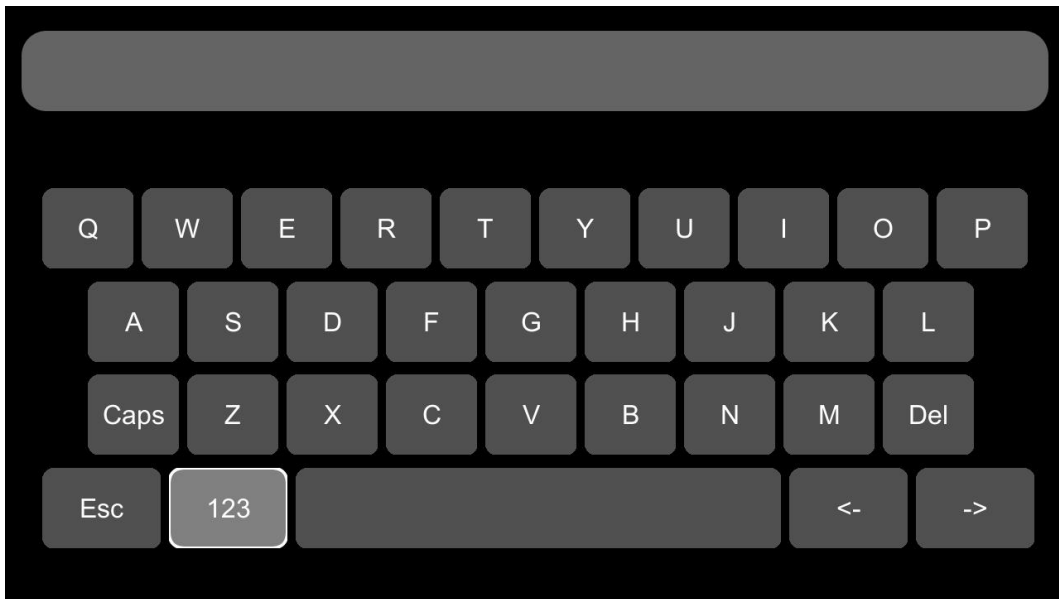

Caps : Switch letter case

Esc : Exit the keyboard interface

Del : Delete the input letters

123 : Switch to the numeric interface

abc : Switch to the English alphabet interface

#+= : Switch to the special character interface

Character Switching Introduction

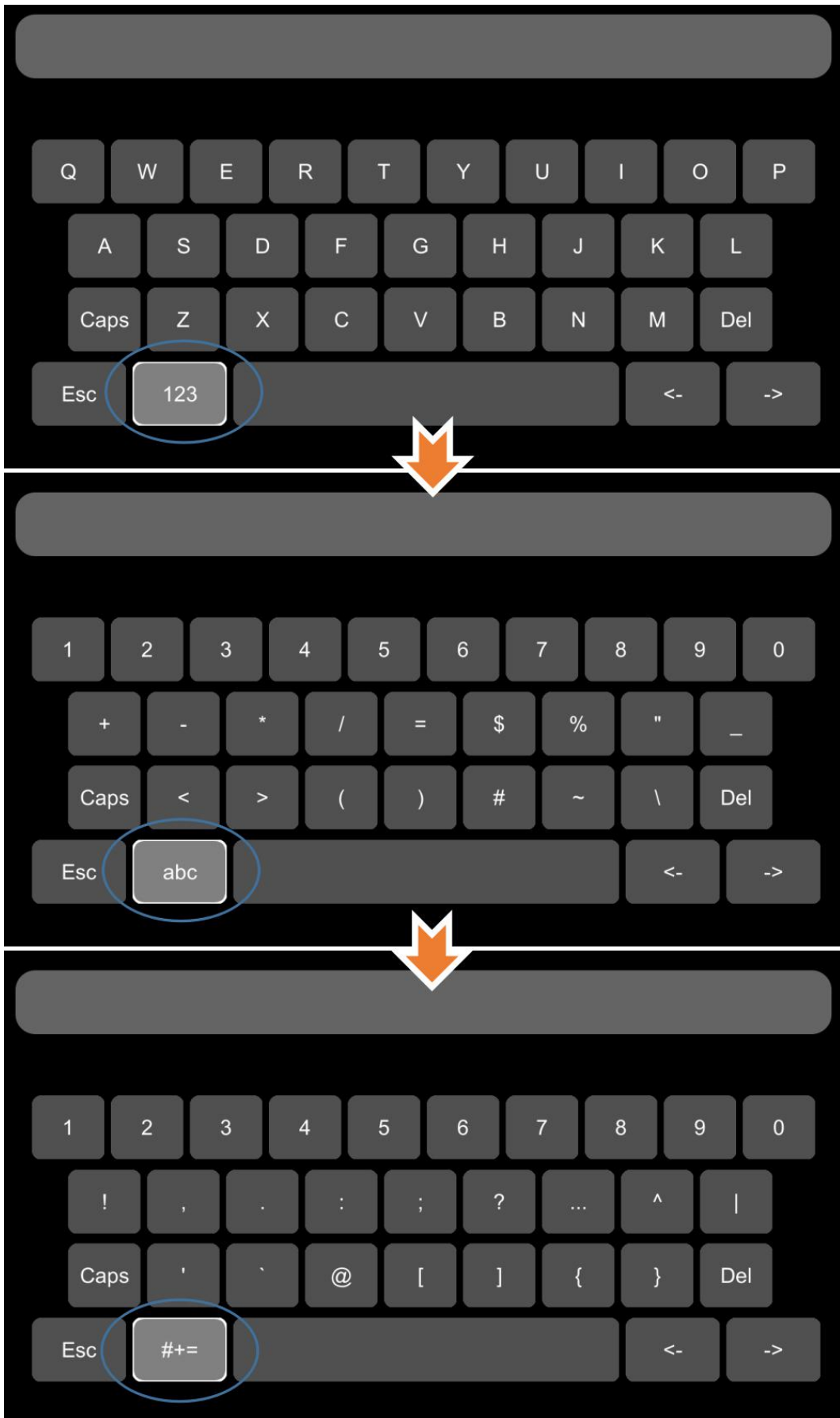

Letter Case Switching Introduction

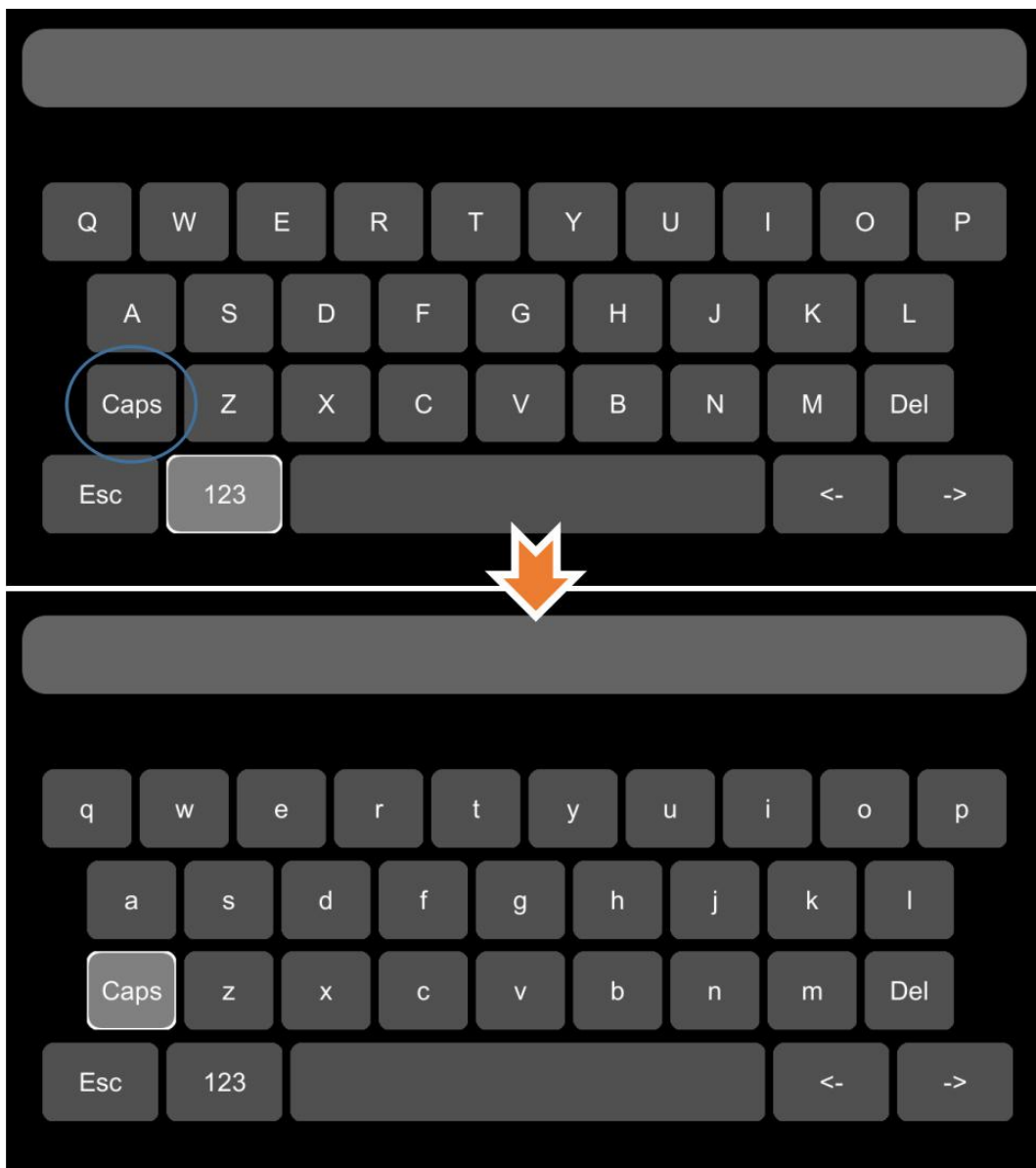

7.4 Manual Recording



Touch this icon to start or stop recording.

7.5 Playback



Video Playback button: Touch this icon to enter the calendar menu.

Green marked date means it has recording files saved on that day. Select the date to enter the video file list, then select the file and touch Play icon to play video. You can select single or multiple videos at a time. Multiple videos can be played in sequence and can be shifted to the next or the previous one.

Specific operation as below.

- Calendar Interface



: Search by month

: Search by year

- Record List Interface (1)

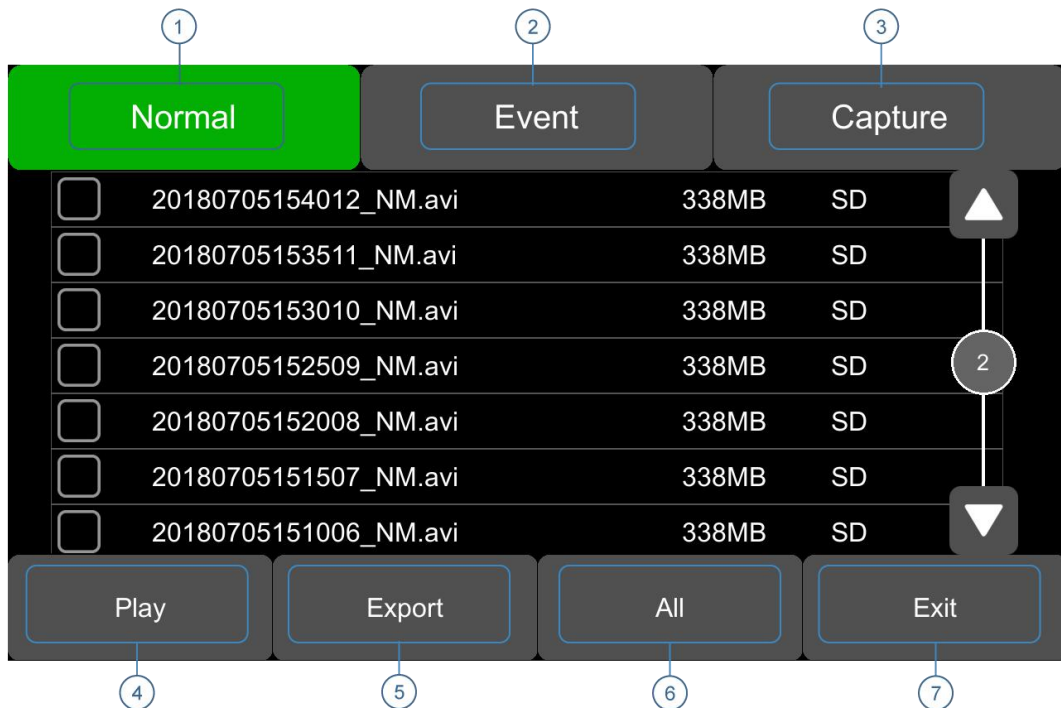

- ① Normal: Regular recording list, including regular recording, power on recording, and schedule recording.

- ② Event: Alarm recording list, including alarm recording 1~6, Motion detection recording, G-force recording, over-speed recording and Panic button recording.

Type	Recording Time Control Mode	View Position
	Manual control	Normal list
Power on recording	Manual control	Normal list
Schedule recording	Pre-setup time	Normal list
Alarm recording 1~6	Event recording setup time	Event list
Motion detection recording	Event recording setup time	Event list
G-force recording	Event recording setup time	Event list
Over-speed recording	Event recording setup time	Event list
Panic button recording	Event recording setup time	Event list
Radar detection alarm recording	Event recording setup time	Event list
inappropriate drivers' action warning recording	Event recording setup time	Event list
Driving safety risk recording	Event recording setup time	Event list
Capture		Capture list

- ③ Capture: Screenshot list
 ④ Play: Play the selected video files
 ⑤ Export: Export selected video files to external USB devices
 ⑥ All: Select all seven files on current page
 ⑦ Exit: Exit
- Record List Interface (2)

There is an abbreviation of record type in the file name, from which you can get the record type of this file.

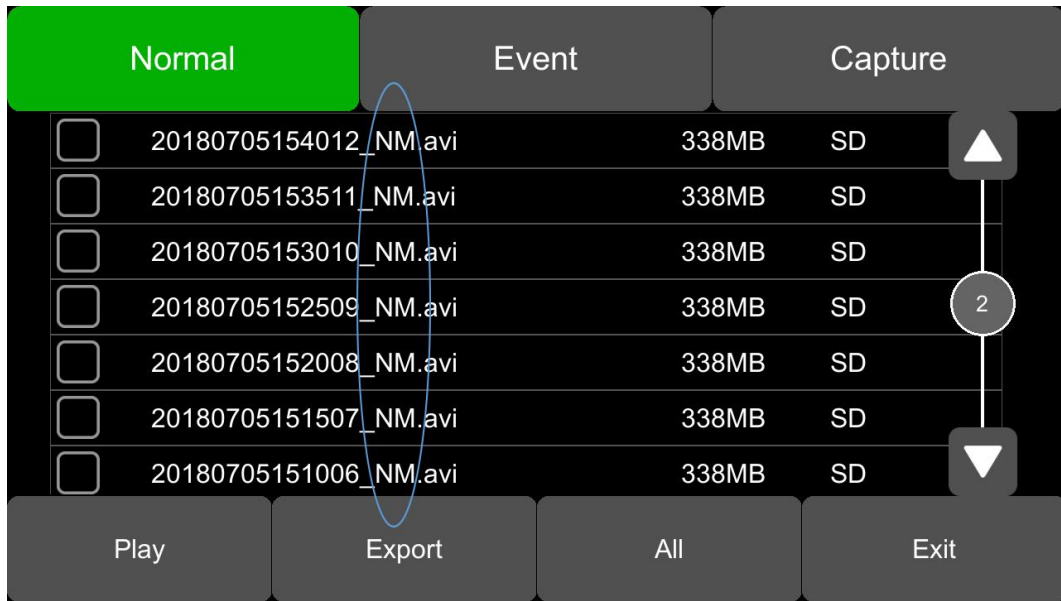

The abbreviations of record types are as following:





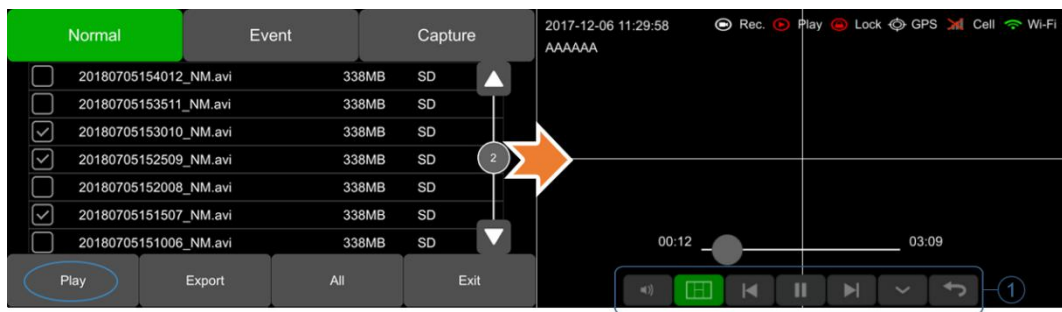

NM	Normal recording	TI	Scheduled recording
MO	Motion detection recording	SP	Over-speed recording
TP	Temperature recording	BT	Panic button recording
A1	Alarm 1 recording	A2	Alarm 2 recording
A3	Alarm 3 recording	A4	Alarm 4 recording
A5	Reverse recording	A6	Alarm 6 (Brake) recording
PB	Pedestrian detection recording	CR	Collision alarm recording
SK	Lane deviation alarm recording	OS	Over speed recording (the speed source is ADAS)
RA	Radar detection recording	ND	No driver alarm recording
FT	Fatigue alarm recording	DS	Distraction alarm recording
CA	Phone using alarm recording	SM	Smoking alarm recording
GS	G-Force recording (easy mode)		

The abbreviations of G-force recording types are as following:

RD (Optional)	RFID recording	AC	Acceleration recording
DC	Deceleration recording	TA	Turn by acceleration recording
TG	Turn by gyroscope recording	IP	Impact recording
TL	Turn left by gyroscope recording	TR	Turn right by gyroscope recording
CP (Optional)	Clip the recording file recording		

- Play Interface



-  : Volume control
-  : Select the playback view modes
-  : Play the previous/next video file
-  : Pause/Resume playing
-  : Hide the menu. Press [Area 1] to display.
-  : Exit playing

7.6 Log



System Log checking, Log export.

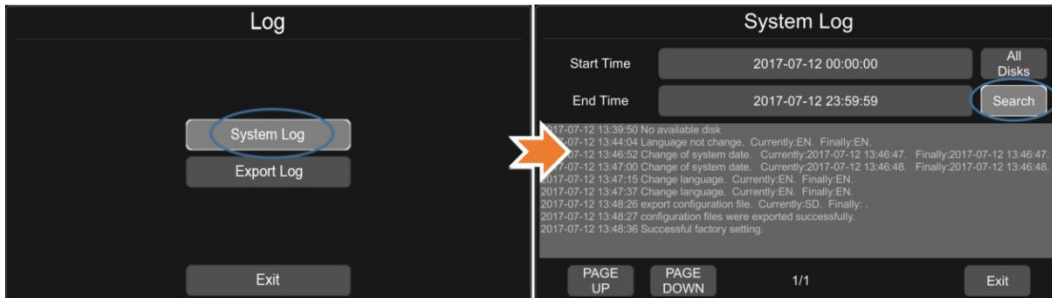

7.7 Display Mode Switching



Display mode switch: Press the icon to display 12 types of mode. The default mode is quad view.

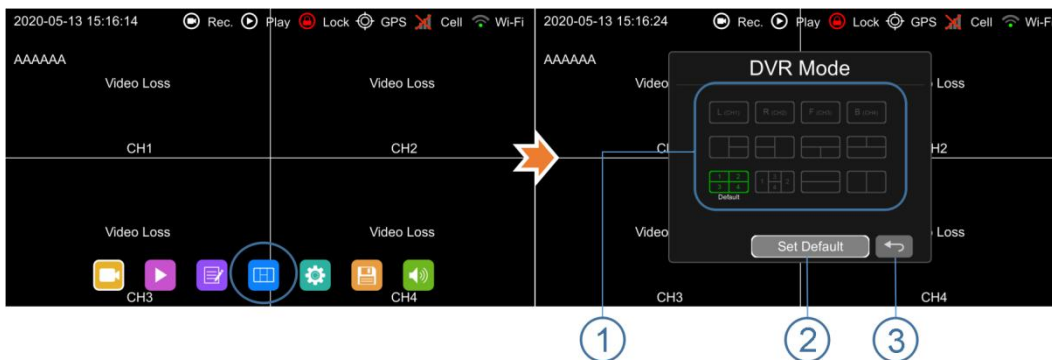

- ① Display mode selection.
- ② Touch the icon to set up the default.
- ③ Exit.

7.8 System



System settings: Touch the icon to enter the setup menu. A window warning of "Unable to record in set-up mode! Continue?" will be popped up, and touch OK to enter.

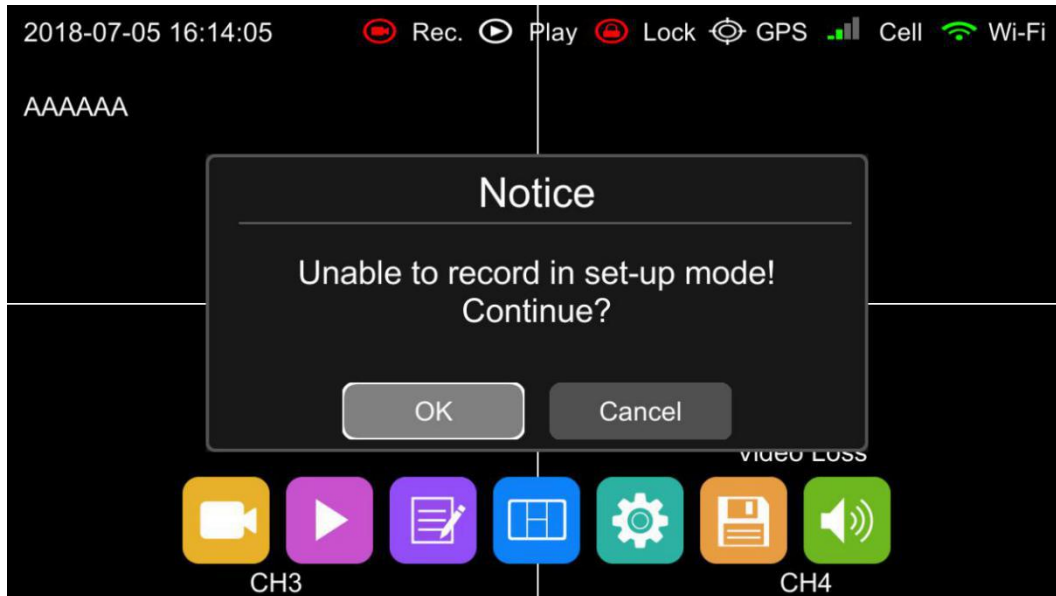

7.9 Disk



Disk management: Touch the icon, then you can view the status of SSD, SD card and USB storage as below.

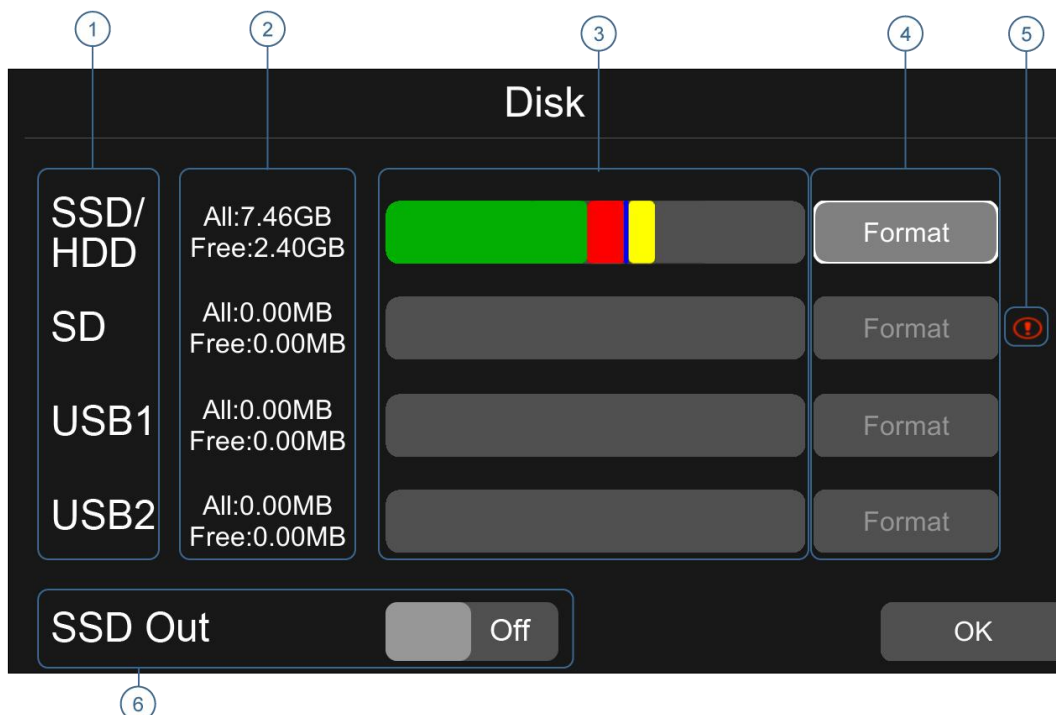

- ① Disk types.
 - ② ALL: The total capacity of individual disk.
 - ③ Green shows the capacity of all the recording files in the Normal list,
Red shows the capacity of all the recording files in the Event list,
Blue shows the capacity of all the pictures in the Capture list,
Yellow shows the capacity of all the other files except those above,
Grey shows the capacity which is not used.
 - ④ Touch to format the disk.
- A window text of “Disk data will be deleted! Continue?” will pop up. Press OK to start formatting the disk.
 - The following picture is an example of formatting USB2.

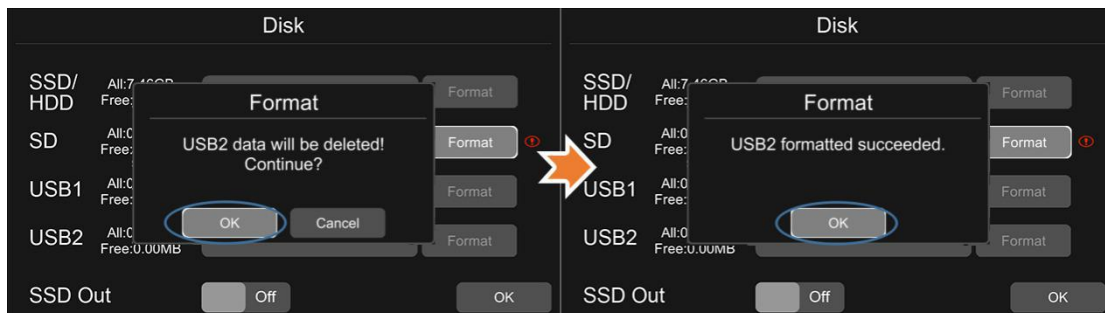

- If the disk could not be formatted, please check if:
 - a. There is a disk in the slot.
 - b. All recordings are set off.
 - c. The Upload Files is set off.
- ⑤ It shows that the disk needs to be formatted before application.
All new disks must be formatted before application.
- ⑥ If SSD Out is set ON, the recording files in the disk could be exported to a computer via USB cable.
Please note that only recordings files can be exported in this way.

7.10 Volume



Volume : value 0~10, default value is 5.

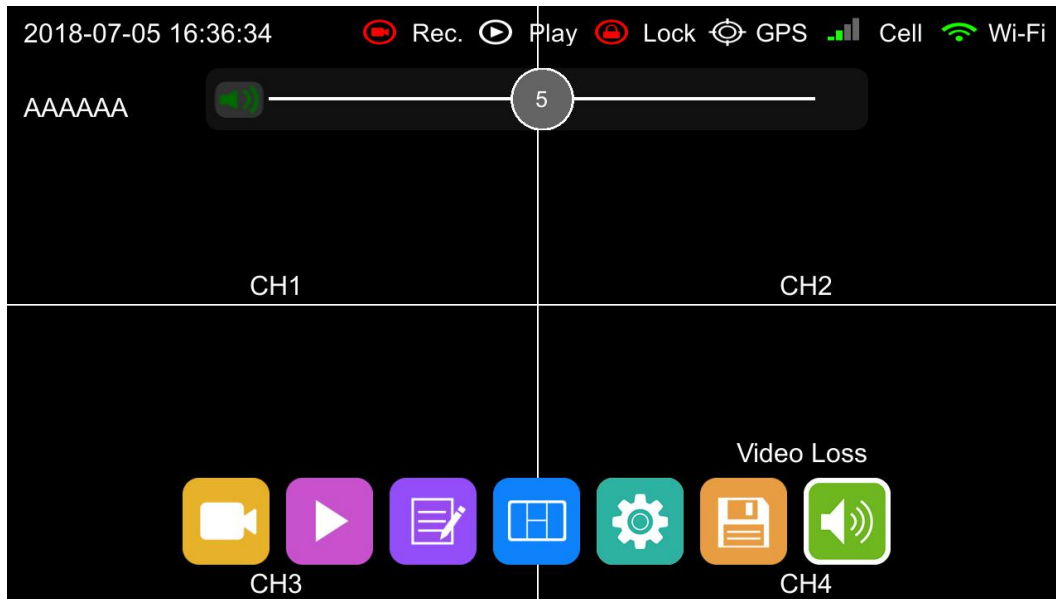

8 Record Setup



8.1 Power On Rec



When "Power On Rec" is set to ON, the device will start recording once it's powered on. Default setting is ON.

8.2 Cyclic Rec



When "Cyclic Rec" is set to ON, new recording files will overwrite the

previous ones when the disk is full. Otherwise, it will stop recording when the disk is full. This function is "ON" by default, and will overlay all video files, including event video files.

8.3 Event Rec

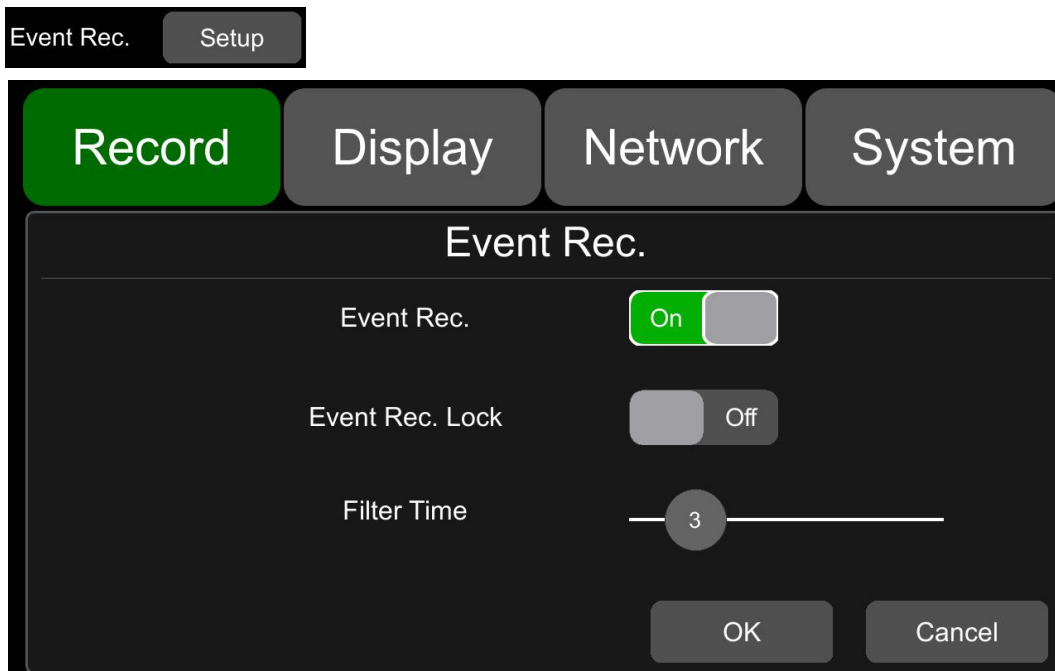

Event Rec.: Event recording refers to the alarm recording triggered by events including motion detection, G-force, alarm 1 ~ 6, panic button, radar detection , inappropriate drivers' action warning , driving safety risk and over speed. If the Event Rec is set to ON and corresponding alarm parameters are set, event recording will be activated when the events above are triggered. If the Event Rec is set to OFF, event recording will not be activated even if an alarm is triggered.

This function is "ON" by default.

Event Rec. Lock: If both the Event Rec. Lock and the Cyclic Rec. are set to ON and all disks are full, new recording files will overwrite all the previous recording files, excluding Event Recording files. When the Event Rec. Lock is set to OFF, Cyclic Rec. is set to ON and all disks are full, new recording files will overwrite all the previous recording files, including Event Recording files.

"Event Rec. Lock" is "OFF" by default.

Filter Time: Time filtering. As shown in the figure, if the same event is triggered continuously, the DVR generates an event message every 3s, and detects whether a new event recording is generated every 3s. After the DVR is connected to the Internet, the event information will be sent to the server. The "Filter Time" minimum setting is 1s, the maximum setting is 15s, and the default value is 3s.

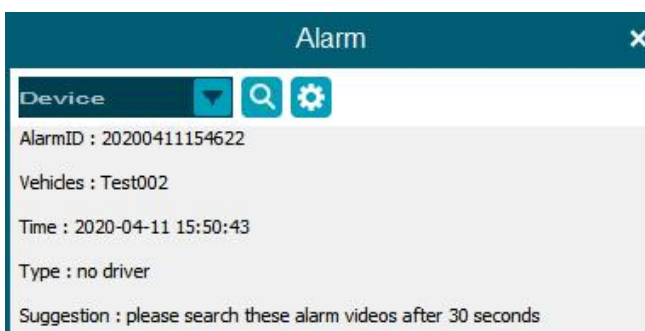

8.4 Video Quality

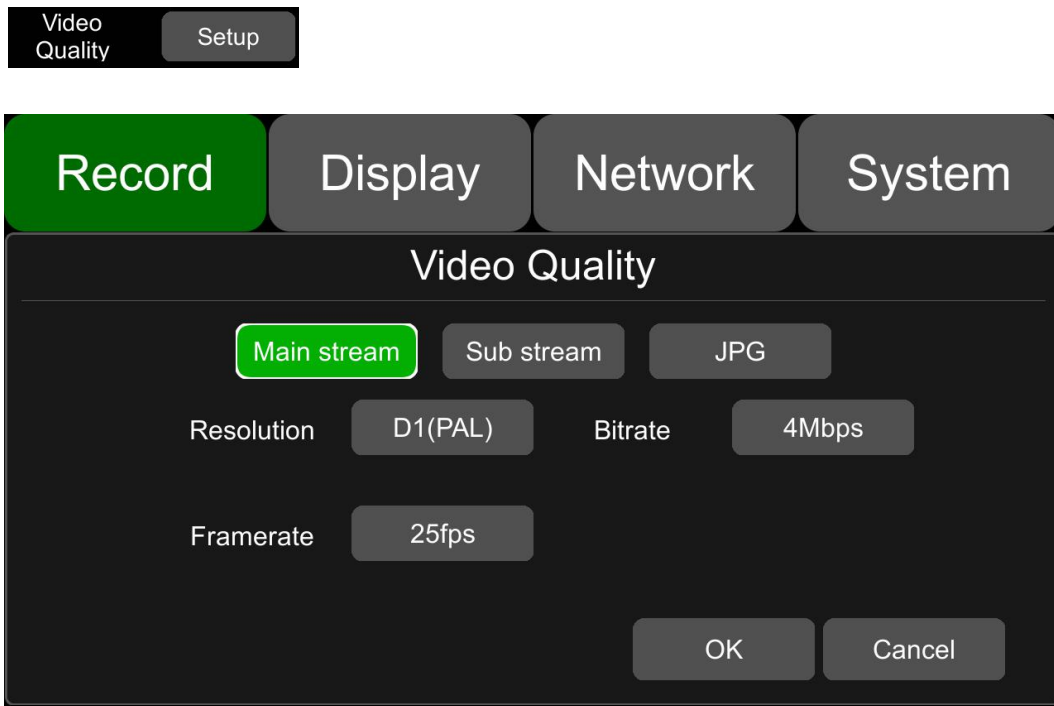

The main stream is used for video storage. The sub stream is used for network transmission.

The default configuration of main stream, sub stream and JPG are as follows:

	Main stream	Sub stream	JPG
Resolution	AUTO	AUTO	25fps
Bitrate	CIF(NTSC)	64Kbps	25fps
Framerate	none	none	Low

① Resolution

There are 5 kinds of optional resolution in main stream menu, 1080P, 720P, D1 (PAL), D1 (NTSC) and AUTO. And there are 3 kinds of optional resolution in sub stream menu, D1 (PAL), D1 (NTSC) and AUTO. The higher the resolution is and the better the video quality is, the larger the video file will be. Therefore, the file size should be taken into consideration during configuration.

In the options of Resolution, AUTO is defined as follows.

Resolution		
	Main stream	Sub stream
AUTO	The device automatically identifies the television mode of the camera and records in this mode at the corresponding channel.	The device automatically identifies the television mode PAL/NTSC of the camera and records in CIF (PAL) CIF (NTSC) mode at the corresponding channel.

② Bit rate

There are 8 kinds of optional bit rates in Main stream and Sub stream menu, 4Mbps, 2Mbps, 1Mbps, 512Kbps, 256Kbps, 128Kbps, 64Kbps and AUTO. The higher the bit rate is and the clearer the image is, the larger the video file will be. Therefore, all factors above should be taken into consideration during configuration.

In the options of Bit rate, AUTO is defined as follows.

Bit rate		
	Main stream	Sub stream
AUTO	If a 1080P camera is connected, the bit rate will be 4Mbps. For a 720P camera, it'll be 2Mbps. And for a D1 camera, it'll be 1Mbps.	Whatever cameras are connected, the bit rate will always be 64Kbps.

③ Frame rate

There are 8 kinds of optional frame rates in Main stream and Sub stream menu: 30fps (NTSC) , 28fps (NTSC) , 25fps, 20fps, 15fps, 14fps, 10fps and 5fps. The higher the frame rate is and the smoother the picture is, the larger the video file will be. (Note: mixed connection of camera with different frame rates is not allowed.)

SSD/SD Capacity	Video Quality	Video File Length
1TB	4 X 1080P / 4Mbps	≈150h
	4 X 720P / 2Mbps	≈300h
	4 X D1 / 1Mbps	≈600h
	1 X 1080P / 4Mbps	≈600h
	1 X 720P / 2Mbps	≈1200h
	1 X D1 / 1Mbps	≈2400h
512GB	8 X 1080P / 4Mbps	≈38h
	8 X 720P / 2Mbps	≈75h
	8 X D1 / 1Mbps	≈150h
	1 X 1080P / 4Mbps	≈304h
	1 X 720P / 2Mbps	≈608h
	1 X D1 / 1Mbps	≈1216h

8.5 Record Channel

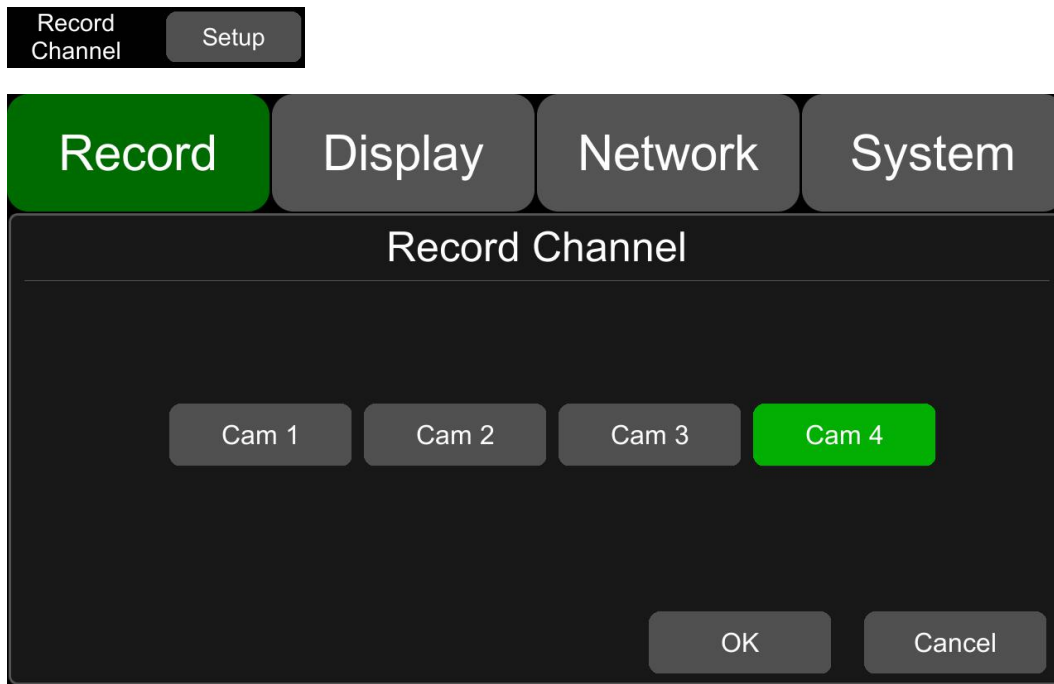

The default configuration is shown above.

After the recording (including all types of recording) is set to ON and the recording channel(s) is selected, the corresponding channel(s) will be recorded. If a record channel is turned off, the corresponding channel will not be recorded even if the recording function is on.

Note: The configuration above is for normal recording, not for event recording. Event recording will record on all channels by default and it can't be changed.

8.6 Event Duration



The default configuration is shown above.

When the "Event Rec" is set to ON, the video file length of event recordings can be set as 5s, 10s or 15s. The video file length will be maximally 5 minutes if an alarm is continuously triggered.

8.7 File Length



The default video file length in AVI and MSV format is 5 min.

AVI format video file length can be set to 5 minutes, 10 minutes, 15 minutes. The length of the video file in MSV format can be set to 2 minutes, 3 minutes, 5 minutes.

File Format	File Length
AVI	5min,10min,15min
MSV	2min,3min,5min

8.8 Motion Sensitivity



The default configuration is shown above.

Motion detection recording and sensitivity level setting: When there is an object moving and its movement amplitude exceeds the preset motion detection sensitivity level, then motion detection recording will be triggered. For such kind of event recording, the pre-recording time is set as 10s and the post-recording time is set according to the configuration in Event Duration above.

Total video file length equals to the pre-recording file length (default time 10s) plus the file length configured in Event Duration.

If motion detection is set to OFF, event recording will not be triggered. Motion detection sensitivity can be set to two levels, low or high. Motion detection recording will be on when Low / High is selected. And it will be off when OFF is selected.

8.9 G-force Sensitivity

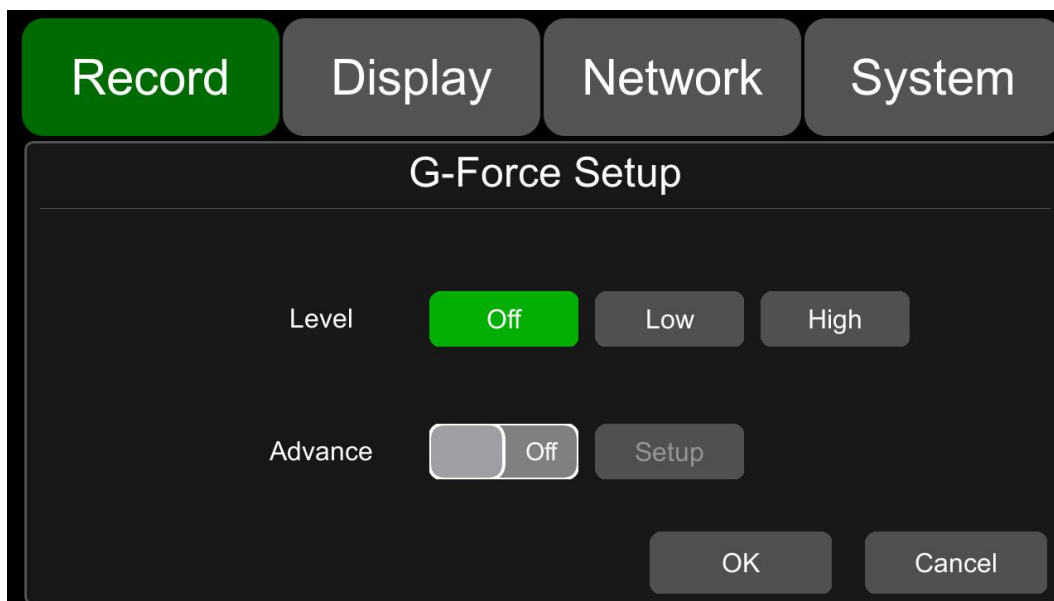

The default configuration is shown above.

There are two optional setting modes for G-force, simple mode and advanced mode. It only requires setting the trigger level of G-force if the simple mode is selected. Detailed instruction is as follow.

When the acceleration or gyroscope of the device reaches the preset sensitivity level, G-force recording will be triggered. For such kind of event recording, the pre-record time will be set as 10s and the post-recording time is set according to the configuration in Event Duration above.

Total video file length equals to pre-recording file length (default time 10s) plus the file length configured in Event Duration.

If G-force triggered recording is off, event recording will not be triggered. G-force sensitivity can be set to two levels, Low / High. G-force triggered recording will be on when Low / High is selected. And it will be off when OFF is selected.

If the advanced mode is set to ON, the simple mode will automatically be disabled. Detailed instruction is as follow.

8.9.1 Principle of G-force Alarm Triggering Detection

The device will measure and detect the acceleration and angular velocity via a nine-axis G-force (transmitting data includes acceleration and angular velocity) when the vehicle moves on or makes a turn. When the acceleration and angular velocity exceeds a certain threshold within a certain period of time, the corresponding alarm will be triggered and recorded. Then the detected data will be uploaded to the cloud (Detection principle is shown in Pic 1.1). For example, according to the detected data, if the acceleration when the vehicle moves on or makes a turn exceeds the certain threshold acceleration “a” during the period “T” (default setting 100ms), then the vehicle’s speed of accelerating or making a turn will be identified as too fast, which is prone to cause traffic accidents.

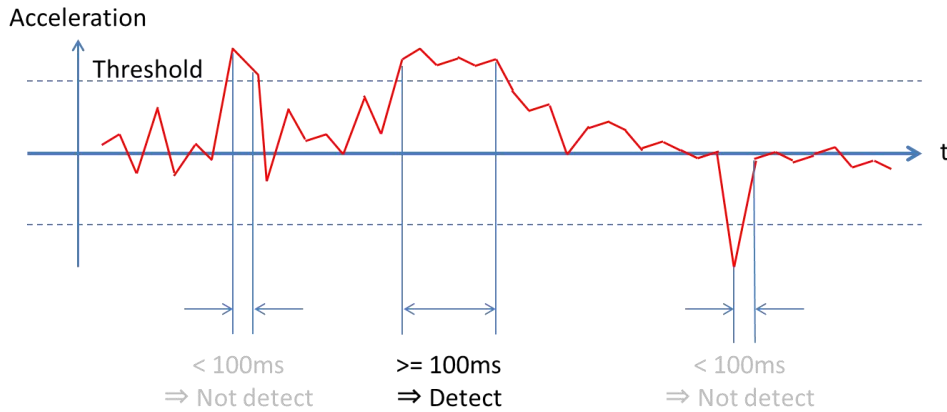

Pic 1.1 Principle of G-force Alarm Triggering Detection

8.9.2 Introduction to G-force Alarm Triggering Setting Interface

Enter the setting interface of the advanced mode of G-force under “Menu” -> “Record” -> “G-force Sensitivity” -> “Setup” -> “Advance” -> “ON”. The meanings of “Acce”, “Dece”, “Turn_Acce”, “Turn_Gyr”, “Impact” and “Filter” are as follow.

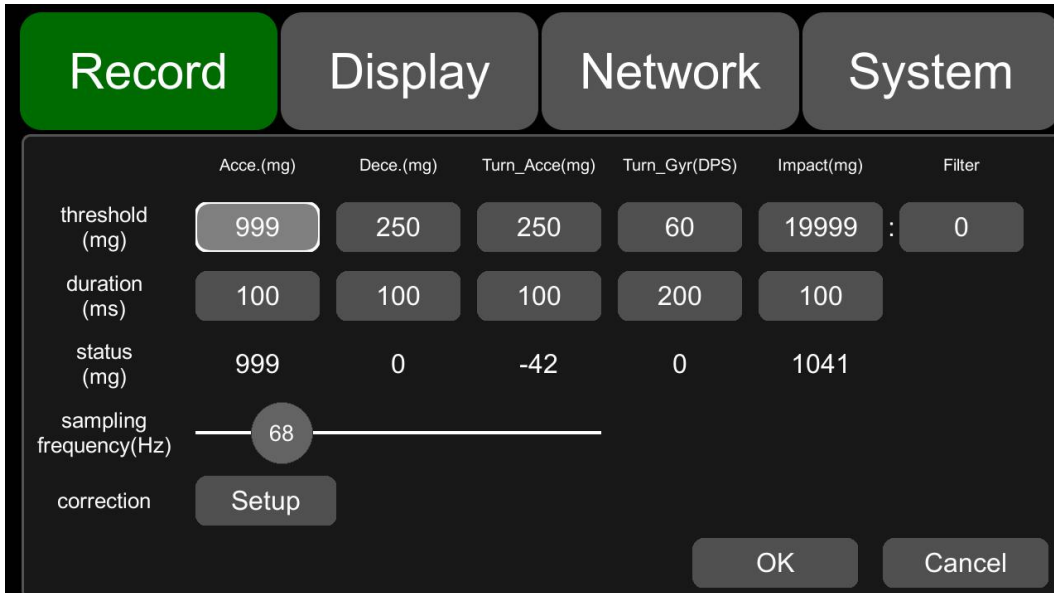

Items	Meanings
Acce.	The value of acceleration when the vehicle moves on (for detecting sudden acceleration)
	When the vehicle is accelerating, the value will be positive number. And when it is decelerating, the value will be zero.
	Unit: mg
Dece.	The value of deceleration when the vehicle moves on (for detecting sudden deceleration)
	When the vehicle is decelerating, the value will be positive number. And when it is accelerating, the value will be zero.
	Unit: mg
Turn_Acce	The value of acceleration when the vehicle makes a turn (for detecting sharp turn)
	When the vehicle is accelerating during left turn or decelerating during right turn, the value will be positive number.
	When the vehicle is decelerating during left turn or accelerating during right turn, the value will be negative number.
	Unit: mg
Turn_Gyr	Making turns and angular velocity of the vehicle (for detecting sharp turn and turning direction)
	When the vehicle turns left, the value will be positive number. When it turns right, the value will be negative number.
	DPS (Radian per Second)
Impact	Acceleration of vehicle collision (for detecting collision event)
	Positive number
	Unit: mg
Filter	Weight coefficient of acceleration on Z-axis of impact(collision)
	Positive number
	The calculation method and scale factor are shown in Table 1.3.

The meanings of “threshold”, “duration”, “status”, “correction” and “sampling frequency” are as follow.

Items	Meanings
threshold	Threshold setting for “Acce”, “Dece”, “Turn_Acce”, “Turn_Gyr”, “Impact” and “Filter”. When the detected value continuously exceeds threshold setting for “duration”, then the alarm recording will be triggered.
duration	Detection time setting for “Acce”, “Dece”, “Turn_Acce”, “Turn_Gyr”, “Impact” and “Filter”
status	Real-time detected value of the corresponding event
correction	Setting for device installation and G-force data correction
sampling frequency	Sampling frequency of the G-force

Table 1.5 G-force Alarm Triggering Setting Interface.

The threshold and detection duration of alarm triggering recording can be modified according to different application environment. The shorter the detection duration is set and the lower the threshold is set, the higher the sensitivity of alarm triggering will be. The unit of acceleration is mg. ($1g \approx 9.8m/s^2$, $1g=1000mg$). The unit of angular velocity is Radian per Second (DPS).

	Default Values	Ranges
Acceleration threshold	225 mg	101~999
Deceleration threshold	250 mg	101~999
Turn_Acce threshold	250 mg	250~999
Turn_Gyr threshold	60 DPS	21~99
Impact threshold	1200mg	101~19999
Filter	0	0~5
Acceleration duration	100ms	1~4999
Deceleration duration	100ms	1~4999
Turn_Acce duration	100ms	1~4999
Turn_Gyr duration	200ms	1~4999
Impact duration	100ms	1~4999

The default values and ranges of thresholds and duration for G-force alarm triggering detection are shown in the table below.

The formula of calculating the acceleration of impact (collision) event is as follow.

$$abs(X) + abs(Y) + abs(Z) * Filter.$$

“abs(X)”, “abs(Y)” and “abs(Z)” are the data from the X, Y and Z axes of acceleration sensors in the vehicle. Filter is the coefficient from the Z axis of acceleration sensor.

Filter rate of Z axis

Sensitivity level	Filter rate
0	100%
1	80%
2	60%
3	40%
4	20%
5	0%

Table 1.3 Acceleration Sensitivity level and value from Z axis for collision detection (Default level: 0)

E.g.: Threshold: 1200 mg; Interval: 100ms

1) Setting value: 5

Detection condition: $\text{abs}(X) + \text{abs}(Y) + \text{abs}(Z) \geq 1200\text{mg}$

2) Setting value: 4

Detection condition: $\text{abs}(X) + \text{abs}(Y) + \text{abs}(Z) \times 0.8 \geq 1200\text{mg}$

3) Setting value: 3

Detection condition: $\text{abs}(X) + \text{abs}(Y) + \text{abs}(Z) \times 0.6 \geq 1200\text{mg}$

4) Setting value: 2

Detection condition: $\text{abs}(X) + \text{abs}(Y) + \text{abs}(Z) \times 0.4 \geq 1200\text{mg}$

5) Setting value: 1

Detection condition: $\text{abs}(X) + \text{abs}(Y) + \text{abs}(Z) \times 0.2 \geq 1200\text{mg}$

6) Setting value: 0

Detection condition: $\text{abs}(X) + \text{abs}(Y) \geq 1200\text{mg}$

The default values are detected as follow.

- (1) If the vehicle accelerates continuously in the positive direction of X axis and if the real-time value of Acce exceeds the threshold continuously for 100ms during driving, then the device will trigger an alarm of Acceleration.
- (2) If the vehicle decelerates continuously (brakes suddenly) in the positive direction of X axis and if the real-time value of Dece exceeds the threshold continuously for 100ms during driving, then the device will trigger an alarm of Deceleration.
- (3) If the vehicle quickly turns to the positive direction of Y axis and if the real-time value of Trun_Acce exceeds the threshold continuously for 100ms during driving, then device will trigger an alarm of Trun_Acce.
- (4) If the vehicle quickly turns to the opposite direction of Y axis and if the real-time value of Trun_Acce exceeds the threshold continuously for 100ms during driving, then device will trigger an alarm of Trun_Acce.

(5) If the vehicle quickly turns to the positive or opposite direction of Y axis and if the real-time value of Trun_Gyr exceeds the threshold continuously for 100ms during driving, then device will trigger an alarm of Trun_Gyr.

8.9.3 Introduction to Installation and Calibration of DEVICE

There are various installation methods when the device is installed in the vehicle, because the device and the vehicle itself have different coordinate systems. The device coordinate system is shown in the picture below. The X axis refers to the front side of the device (the side with LED lights), the Y axis refers to the left side of the device (the side without lock). And the Z axis refers to the vertically upward direction when the device is installed.

Z-axis (in vertical upward direction)

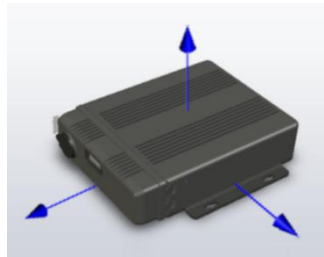

X-axis (the side with LED light)

Y-axis (the side without lock)

The vehicle coordinate system is shown in the picture below. In the coordinate system, the forward direction of vehicle is set as Forward axis and the left direction of vehicle is set as Left axis. There are multiple possible ways to install the device.

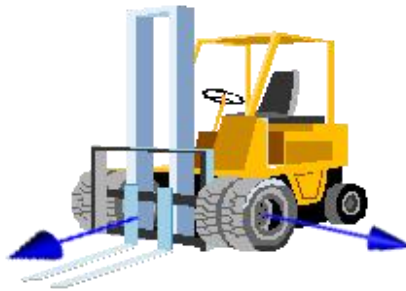

Forward

Left

As shown in Pic 1.2 below, there may be multiple installation positions for the device. In addition, there might be a slight tilt in the device installation process. So it requires calibration via the data from G-force.



Pic 1.2 Possible Installation Position of the device

8.9.4 Device Installation Method Selection and Installation Correction

Forward and Left refer to the forward moving direction and the left moving direction of the vehicle. They help determine the directions of the vehicle with corresponding axes of the device, which is used to determine the installation method of the device.

Click the button “Forward” and “Left” to set the forward axis direction of the device relative to the vehicle. For example, if “Forward” is set to +X and “Left” is set to +Y, it means when the vehicle is moving forward, the forward direction of the device is the positive direction of the X-axis of the device. If “Forward” is set to -Z and “Left” is set to +Y, it means that when the vehicle is moving forward, the forward direction of the device is the opposite direction of the Z-axis and the positive Y-axis direction of the device is the left direction of the vehicle, that is to say, the device is vertically installed on the vehicle and its bottom is placed towards the front direction of the vehicle.

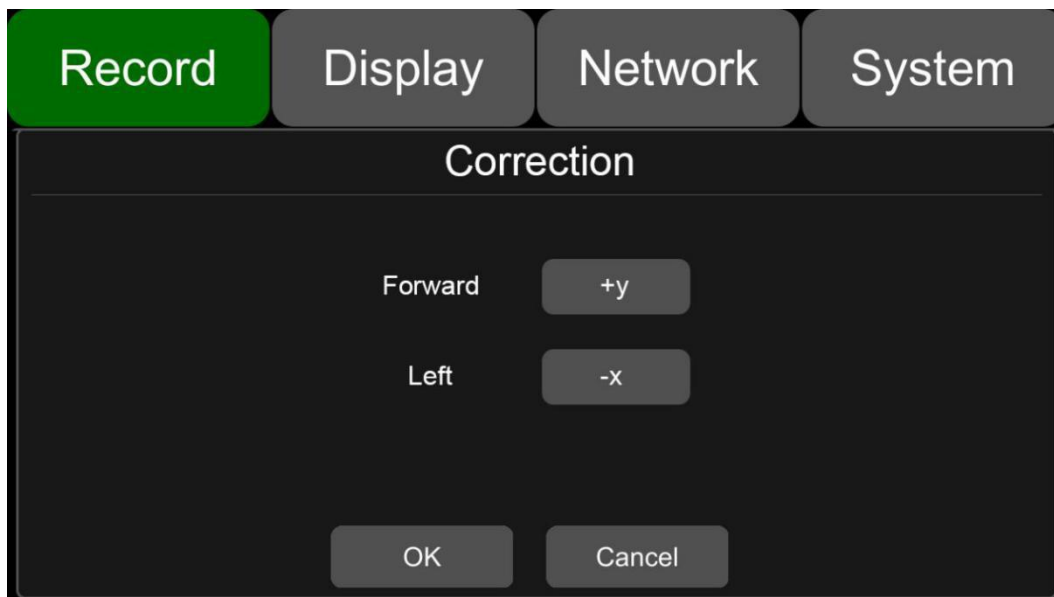

Installation Method Setting Interface

When the setting is finished, click the button OK to exit the interface. Please ensure that the vehicle stays still for more than 1s after the setting is finished, so that the system can apply the calibration procedure. When the data of Status (real-time sensor data) is observed changed to close to 0, it means the calibration procedure is completed.

WARNING: The device installation must be calibrated before put into use. During the calibration process, the vehicle must be parked on a flat area in a static position and the calibration time shall not be less than 1s. When the device is installed for the first time or re-installed and when the installation position changes obviously, the installation position should be re-selected and re-calibrated.

8.10 File Type



Set video format. Record video files in AVI format by default.

8.11 Record Audio



Set the recording audio of the channel. When the recording channel is selected, the audio of the channel will be recorded in the recording file. If this channel is not selected, there is no audio in the recording of this channel. The default configuration is shown below.

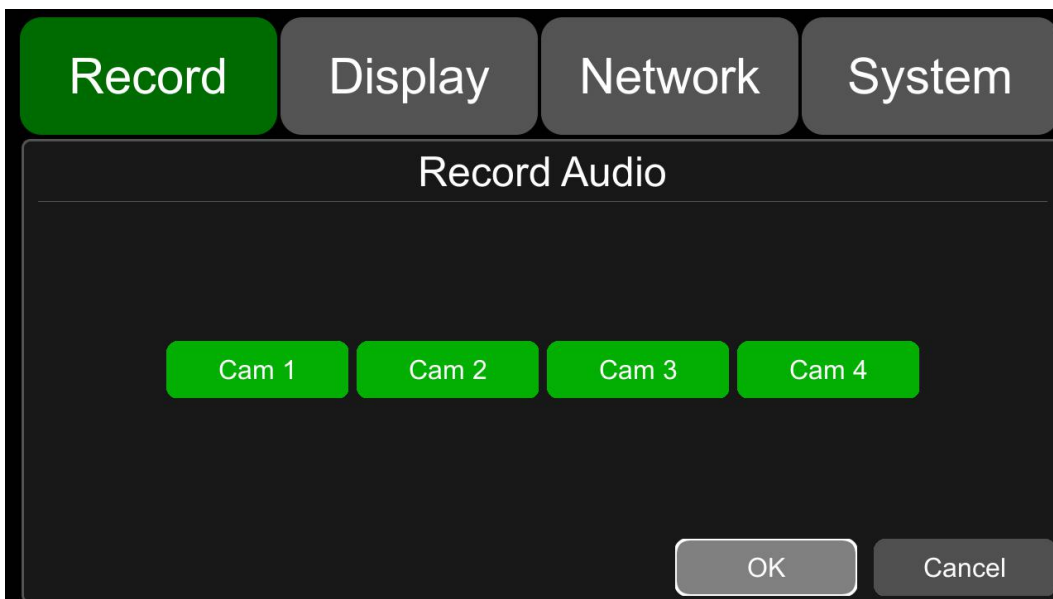

9 Display

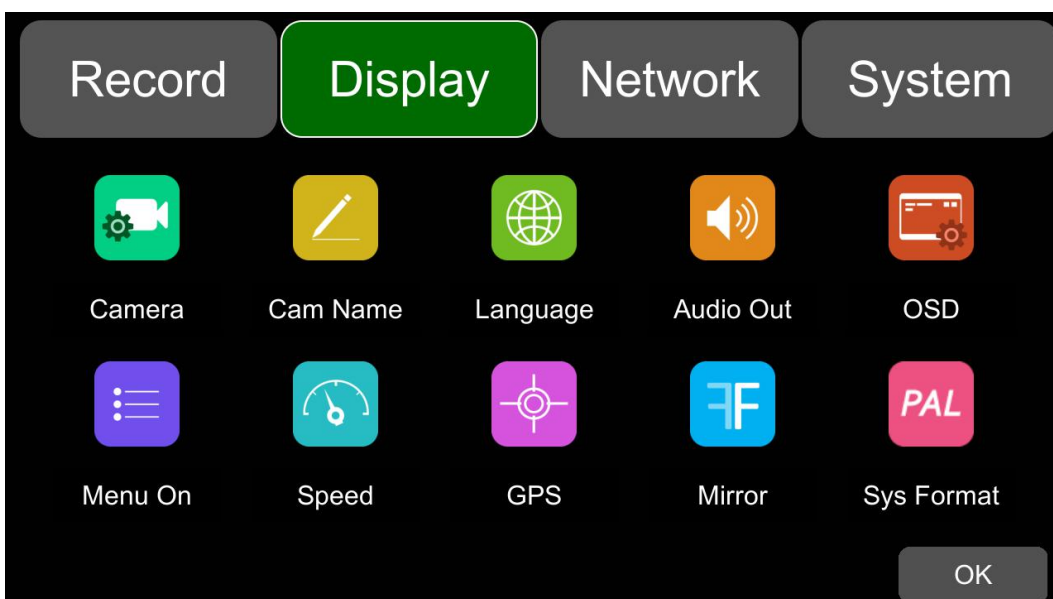

9.1 Camera Display Setting



Camera parameter setting for each corresponding channel includes brightness, contrast, saturation and hue. All default settings are 50. To change the value, drag the bar to left or right to decrease or increase.

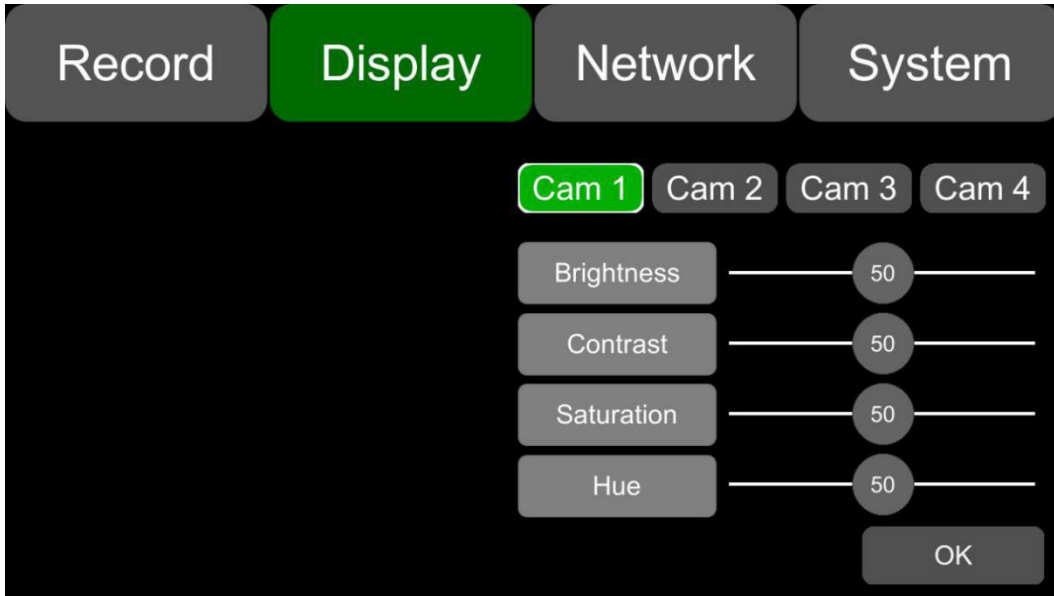

9.2 Camera Name Setting



Camera names are displayed at the bottom of each channel. Touch the camera name on the menu, a keyboard will pop up to input a new camera name. Maximum 8 characters can be entered and the camera name must NOT be blank. The default configuration is shown below.

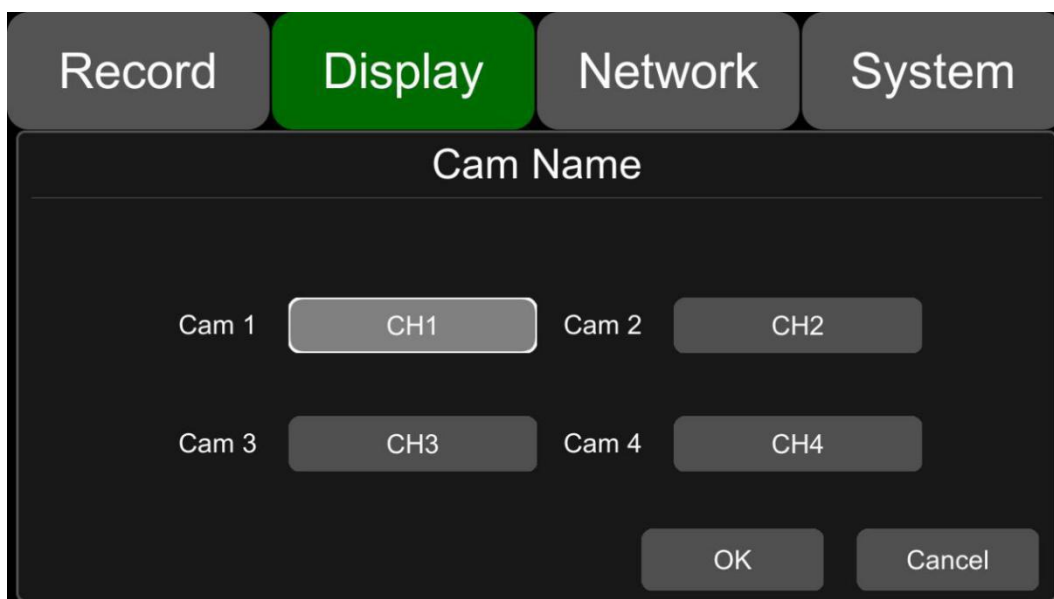

9.3 System Language Setting



English and Spanish are available in the menu for your options. The default language is English.



9.4 Audio Out



Select the audio output channel in multi-display mode. The default configuration is shown below.

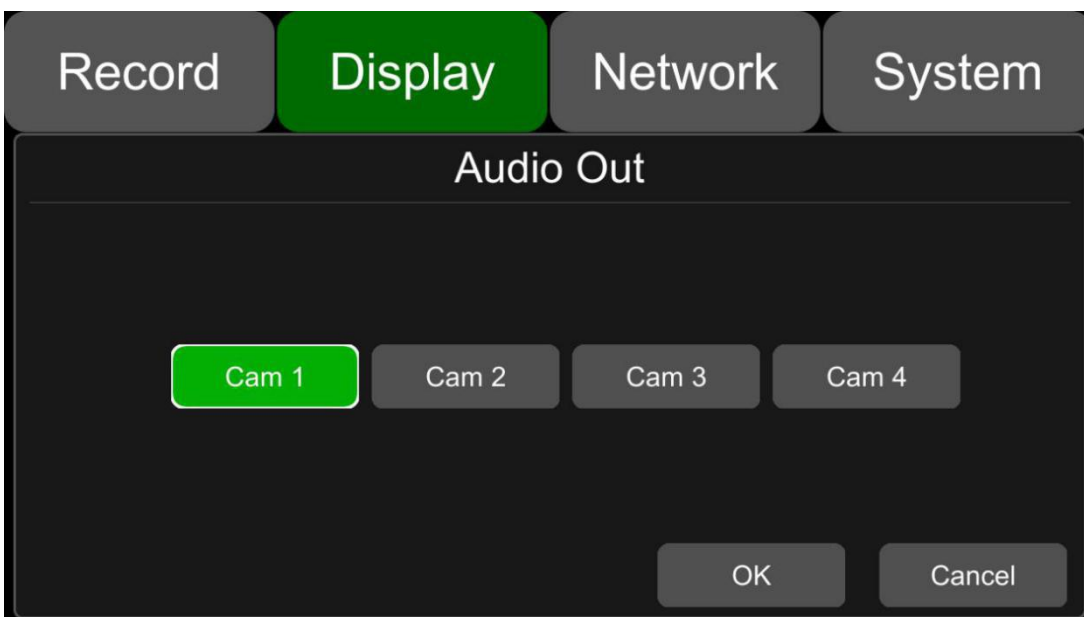

9.5 OSD Display Setting



Time, Camera name, License number and Speed can be selected whether to display or not. If it is on, the information will be shown in the live and the playback video. The default configuration is shown below.

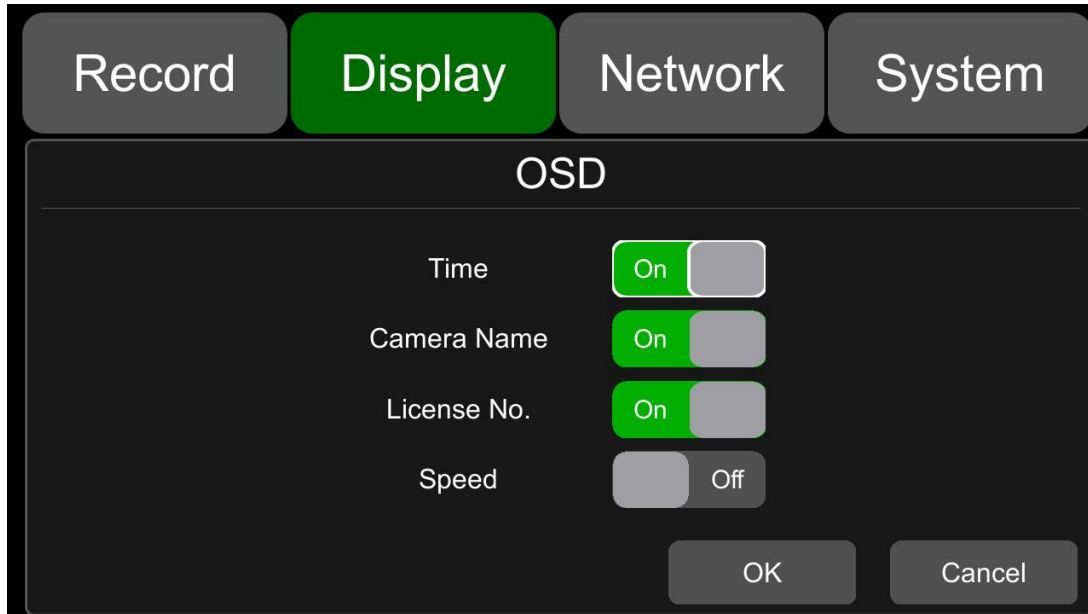

9.6 Menu on



Set the menu display duration. The default configuration is shown below.

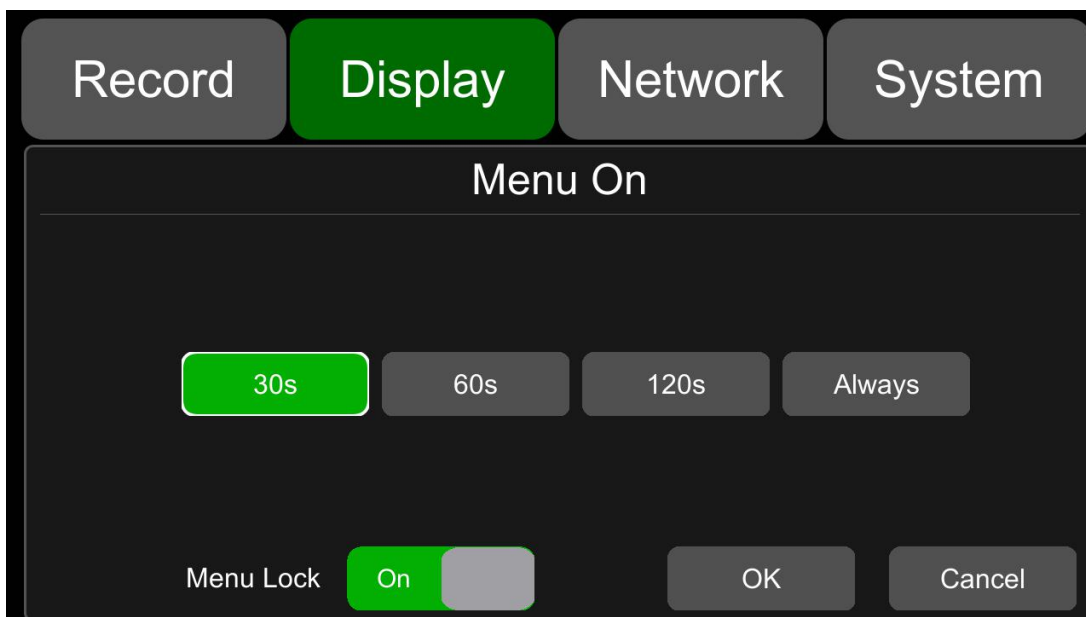

Menu on:

Duration can be set to 30s, 60s, 120s and Always. When it is set to 30s, 60s, 120s, it means that the menu will disappear if there is no operation in 30s, 60s or 120s. When it is set to Always, the menu will always be there. Please be noted that the recording will stop when menu is on. It is not suggested to set the duration to Always in order not to affect the recording.

Note: If you enter the menu, the recording will stop. In order not to affect the recording, it is not recommended to set to “Always”.

Menu lock:

When it is On, permission is required to enter the menu.

When is it Off, no permission is required to enter the menu.

Username and password are required if to change the status of the menu lock.

9.7 Speed



Speed setting:

The data source of overspeed comes from GPS. Speed unit is optional: Km/h or Mile/h.

Overspeed threshold can be set by user. Speed refers to the current speed of the vehicle. If the Speed exceeds the vaule of the Overspeed, the overspeed alarm recording will be triggered.

The alarm switch is to set the over-speed alarm recording ON and OFF. If it is ON, the overspeed alarm recording will be triggered when the vehicle is speeding. If it is OFF, the overspeed alarm recording will not be triggered.

The default configuration of each item is as follows.

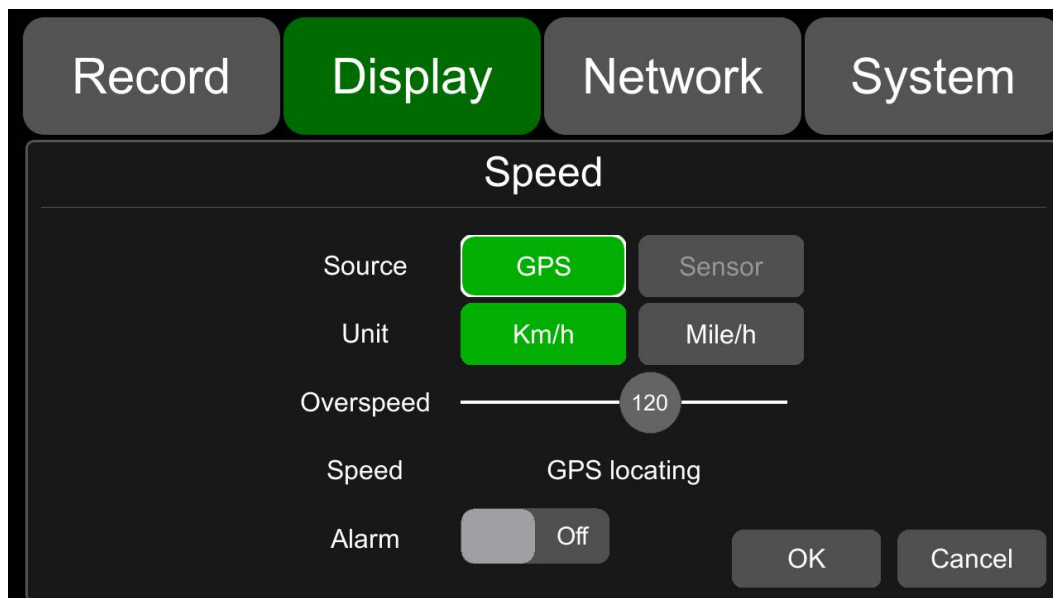

9.8 GPS



When the GPS antenna is properly installed, the latitude, longitude and speed will be recorded. The menu provides the GPS information including latitude, longitude, available satellites and searchable satellites.

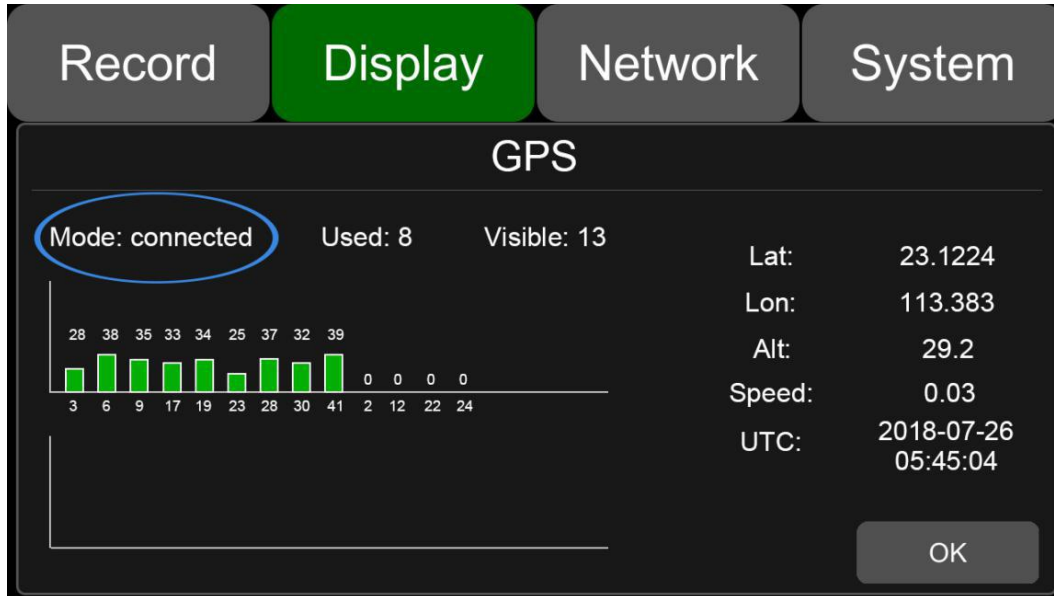

Mode: indicates the GPS connection status.

Used: indicates the number of available satellites.

Visible: indicates the number of searchable satellites.

9.9 Mirror



Horizontal and vertical flips of all channels are turned off by default.

set to "ON", the corresponding video channel is flipped horizontally; set to "OFF", the corresponding channel is displayed normally, without flipping.

The setting steps are shown in the figure below:

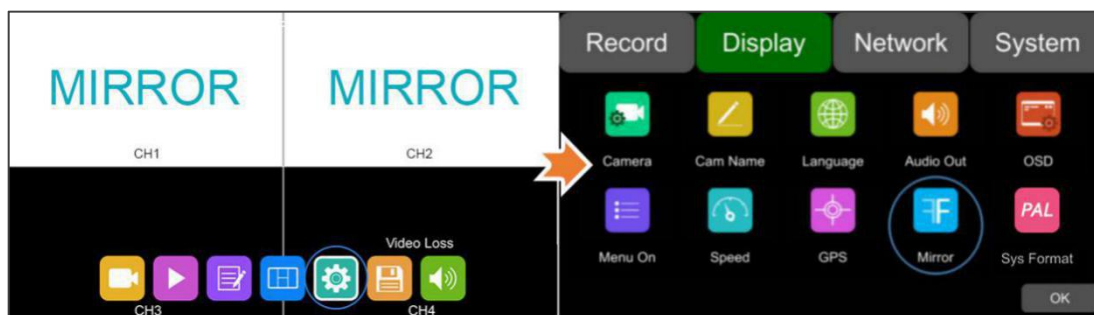

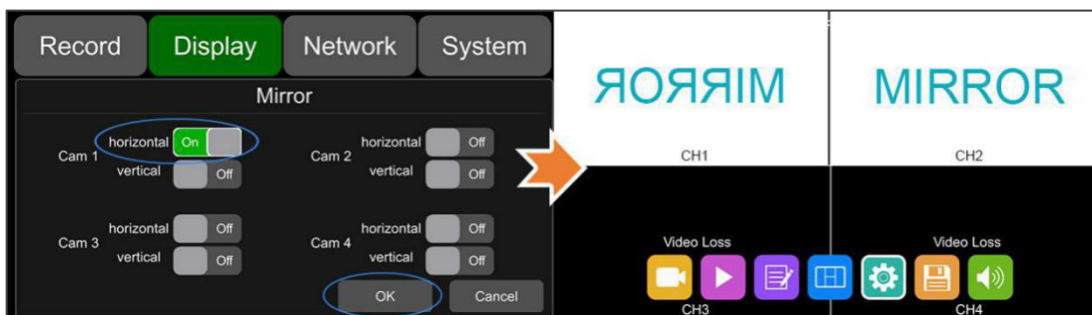

Vertical: set to “ON”, the corresponding channel flips vertically; set to “OFF”, the corresponding channel displays normally, without flipping.

The setting steps are shown in the figure below:



9.10 System Format Setting

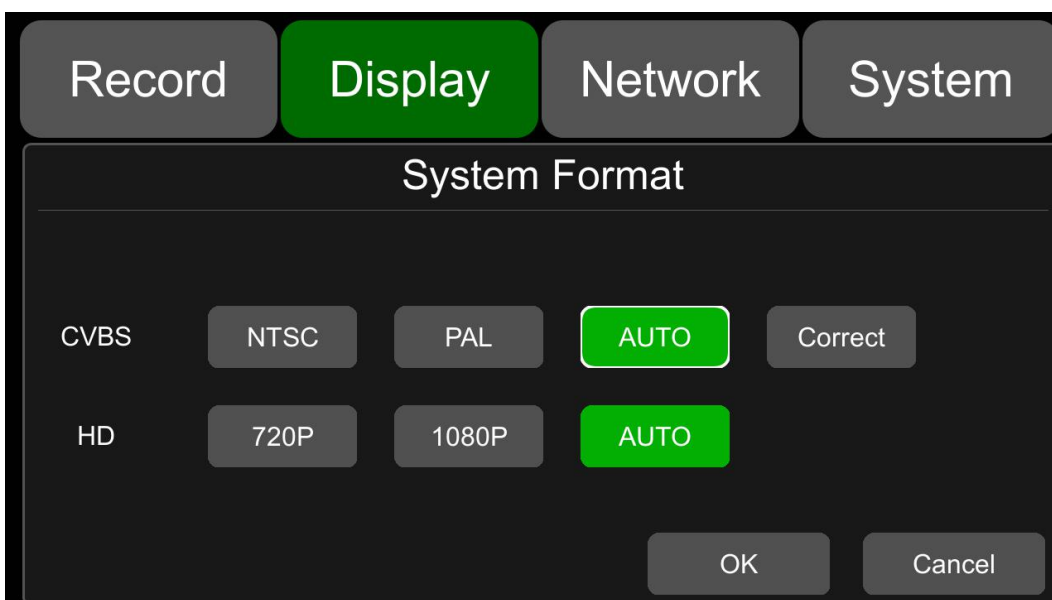

The default configuration is shown above.

CVBS : Standard definition display

HD : HD display

Correct: When the interface displayed on the display screen is not complete, the display interface can be reduced. Each unit of reduction is two pixels, and the maximum can be reduced by 64 units. When the interface is reduced, the DVR can only be operated by the remote control.

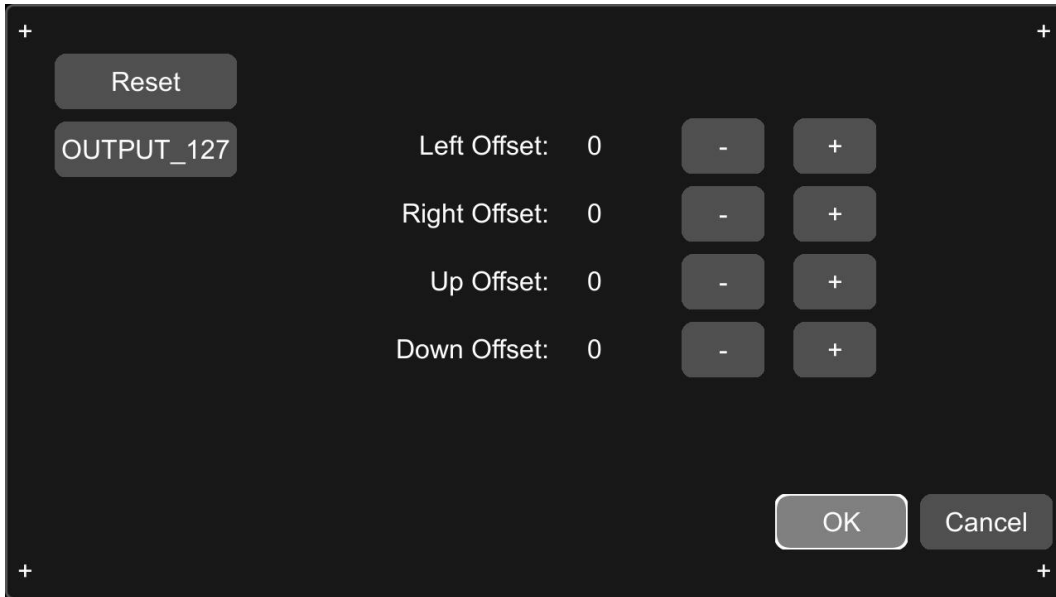

10 Network

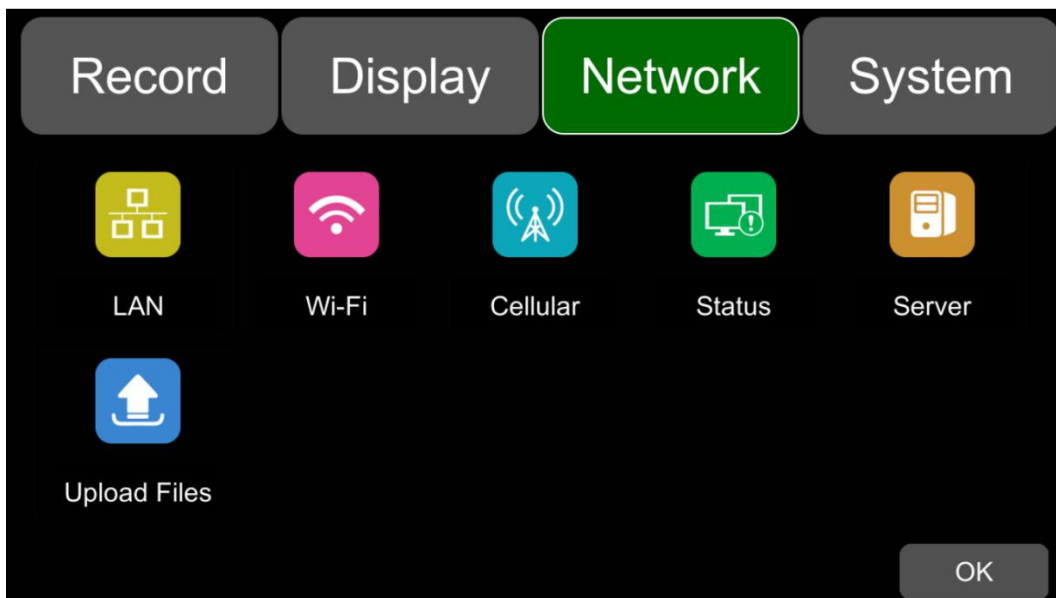

10.1 LAN and Server Setting



Setting	Value
DHCP	Off
IP	192.168.31.88
Mask	255.255.255.0
Gateway	192.168.31.1
MAC	7E:97:15:D3:21:7A

The default configuration is shown above.

- DHCP: Dynamic Host Configuration Protocol. Set On for dynamic IP and Off for static IP. Static IP must be manually input with IP address, mask and gateway. MAC address can be automatically assigned or revised.

- LAN connection

Step 1: Connect the LAN cable to the DVR.

Step 2: Go to “Network - LAN” page.

Setting	Value
DHCP	Off
IP	192.168.100.188
Mask	255.255.255.0
Gateway	192.168.100.1
MAC	7e:97:15:d3:d3:7a

Step 3: If DHCP is set to ON, a dynamic IP will be automatically matched. If DHCP is set to Off, input the IP, mask, gateway and MAC manually.

Step 4: Touch OK to exit.

Step 5: Go to “Network - Server” page.

Step 6: Input LAN Server IP and Port. Touch OK to save the settings.

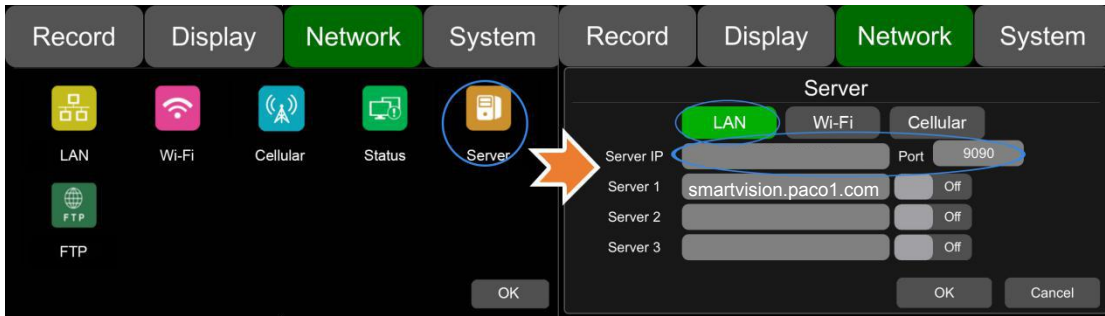

10.2 Wi-Fi Network Setup and Server Setup

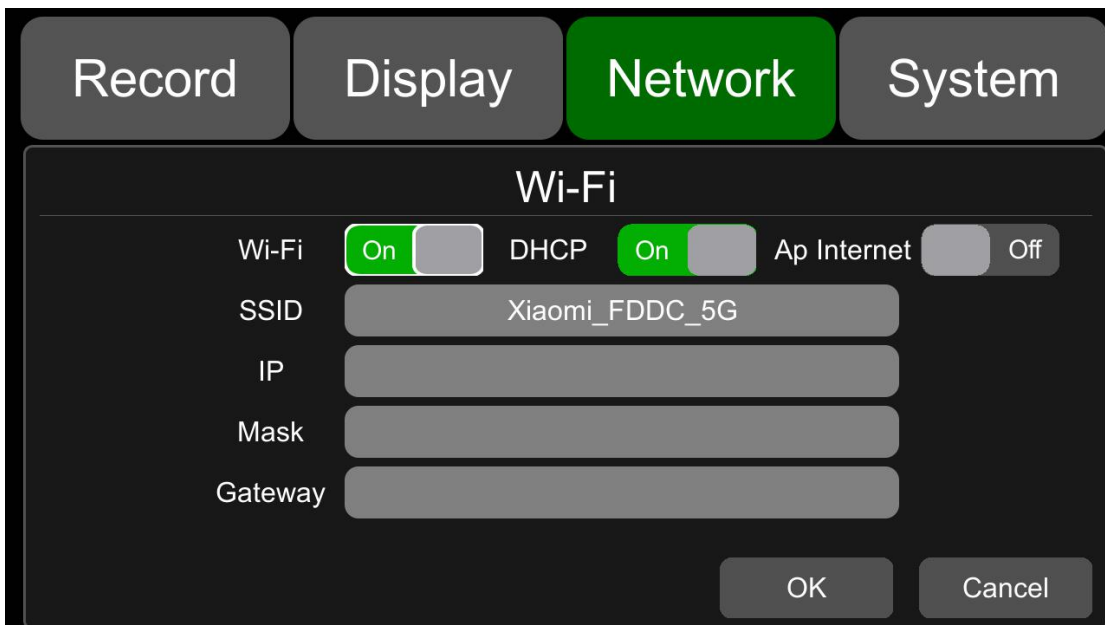

The default configuration is shown above.

Wi-Fi: ON/OFF

DHCP: Dynamic Host Configuration Protocol. Set On for dynamic IP and Off for static IP. Static IP must be manually input with IP address, mask and gateway. MAC address can be automatically assigned or revised.

SSID: Wi-Fi hotspot list.

AP Internet: The hotspot of the device can be found on mobile phones when it is On.

- Wi-Fi connection

Step 1: Make sure Wi-Fi hotspot is available.

Step 2: Connect the Wi-Fi antenna to connector ③ of the device rear panel.

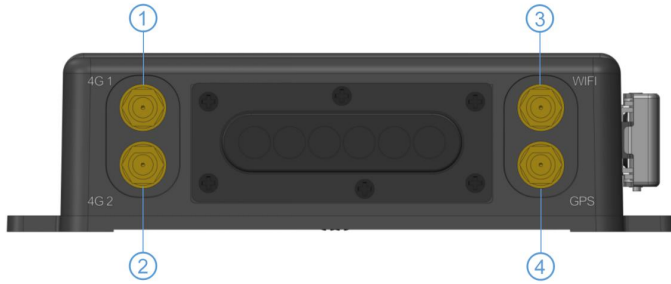

Step 3: Go to Wi-Fi setup interface, set Wi-Fi to ON and DHCP to ON.



Step 4: Touch SSID sub-menu to select the hotspot and input the password.

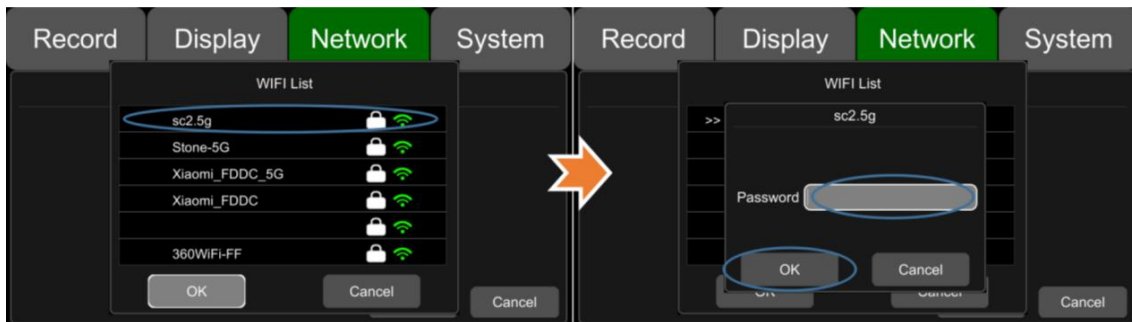

Step 5: Touch OK to exit.

Step 6: Go to "Network - Server" page to input Wi-Fi Server IP and Port. Touch OK to save the settings.

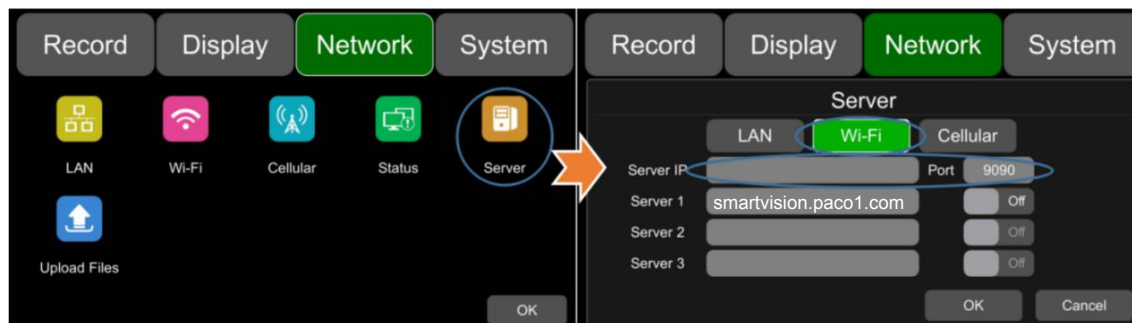

Step 7: Wi-Fi network status and server status can be checked on “Network - Status”.



10.3 2G/3G/4G Control and Setup

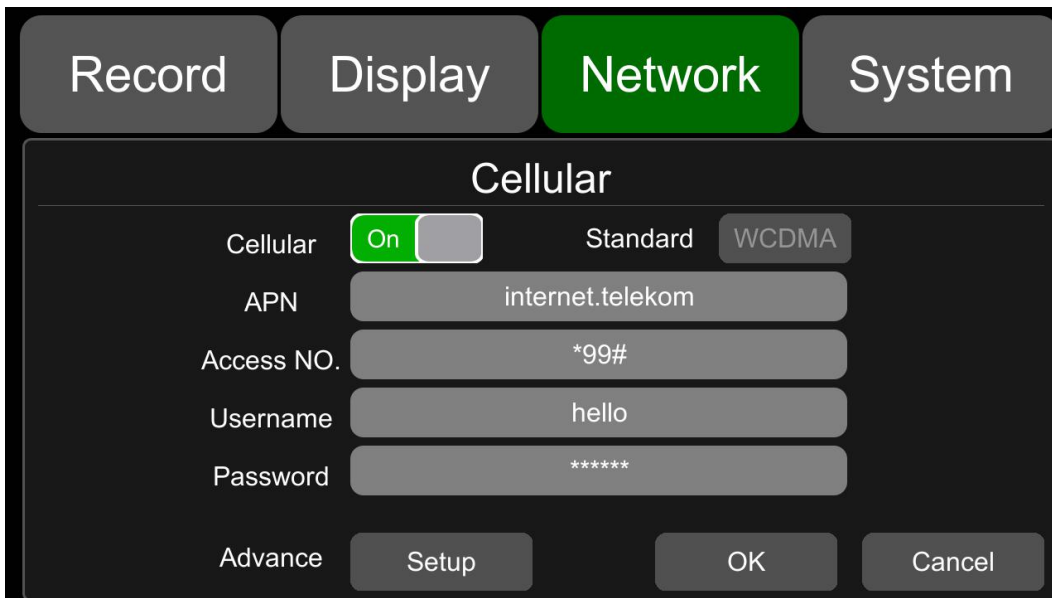

The default configuration is shown above.

Cellular: Cellular is on, meaning that 2G/3G/4G is on.

Standard: WCDMA is set by default.

APN & Access No.: APN is required to enter. Access No., Username and Password are normally left as default setting. If connection is not successful under the default settings, please consult your local network carrier.

OK: Save the settings and exit.

Cancel: Cancel the settings and exit.

- 2G/3G/4G connection

Step 1: DVR can search 2G/3G/4G signals locally.

Step 2: Connect the 2G/3G/4G antenna to connector ① of the device rear panel.

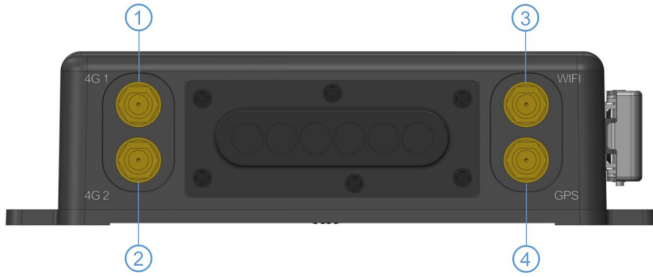

Step 3: Open the device front panel and insert the SIM card.

Step 4: Go to Cellular setup interface and set Cellular to ON.



Step 5: Enter the correct APN.

Step 6: Touch OK to exit.

Step 7: Input the 2G/3G/4G Server IP and Port on "Network-Server".

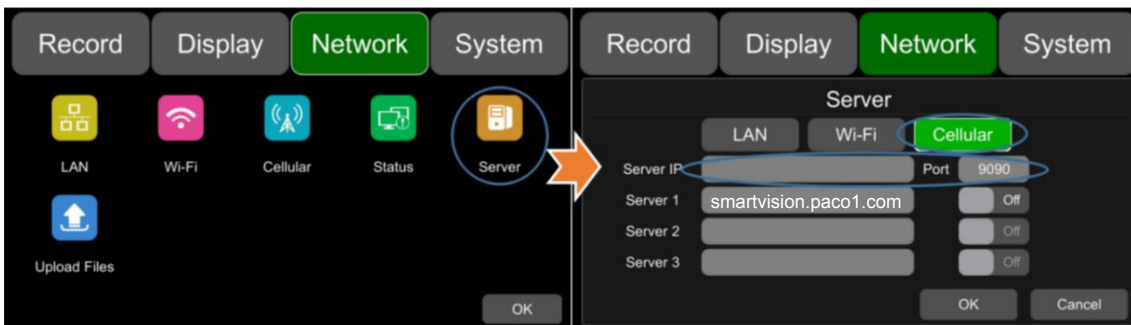

Step 8: Cellular network status and server status can be checked on "Network - Status".

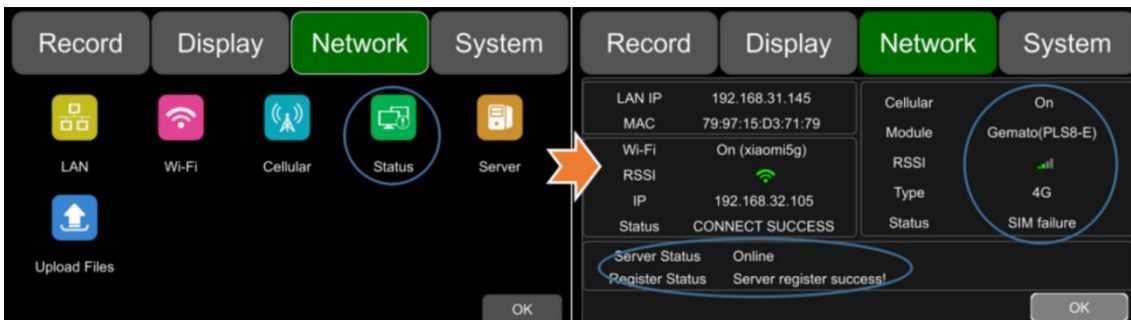

10.4 AP Internet Setup

- Steps to connect AP Internet

Step 1: Connect the DVR to the internet through Wi-Fi or 2G/3G/4G. Please refer to Chapter 10.2 and 10.3 for connection.

Step 2: Set the AP Internet to ON.



Step 3: Search and connect to the Wi-Fi hotspot of the DVR with other mobile devices. The SSID name of the hotspot is prefixed with "WFD-" and followed by the serial number of the device. "WFD-" default password is ap12345678.

10.5 Network Status



Network Status: LAN IP address, MAC address, Wi-Fi network status, Wi-Fi IP address, Wi-Fi signal strength, cellular network status, cellular signal strength and server status can be checked.

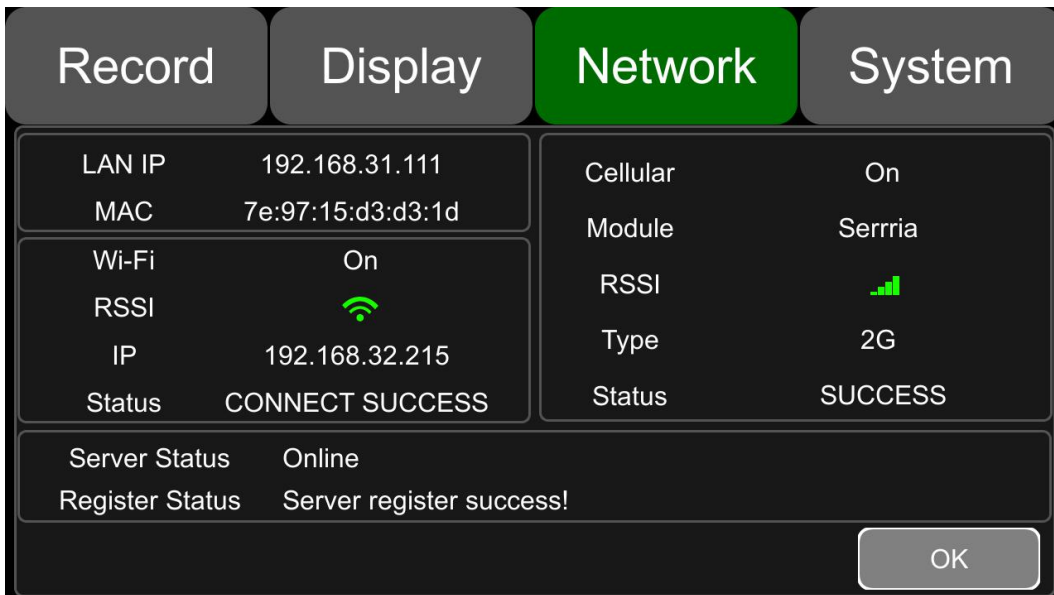

LAN IP: The static IP set on Network-LAN page or the dynamic IP obtained automatically.

MAC: The static physical address set on Network-LAN page or the dynamic physical address obtained automatically.

Wi-Fi: Status indication.

Wi-Fi RSSI: Wi-Fi signal strength indication.

Wi-Fi IP: Static IP obtained from Network-Wi-Fi page or dynamic IP address.

Wi-Fi status: CONNECT SUCCESS or GET IP ERROR.

Cellular: Status indication.

Module: The Cellular module brand.

Cellular RSSI: 2G/3G/4G signal strength indication.

Cellular Type: 2G, 3G or 4G, indicating the actual signal received.

Cellular Status: please refer to the descriptions and indications below.

Description	Indication
Module initialization	Cellular module is initializing.
Module exception	Cellular module is in exception.
No SIM card	No SIM card is found in the DVR.
Cpin locked	Cpin is locked.
Signal abnormal	Signal is abnormal.
Networking failure	Network connection is failed.
SUCCESS	Network connection is successful.

Server Status: Online / Offline.

Register status: Reasons for failed server connection.

10.6 Server



The function of server setting is mentioned in Chapter 10.1, 10.2 and 10.3. The default server 1 of LAN, Wi-Fi and Cellular is smartvision.paco1.com, and the default port number is "9090".

The screenshot shows a menu with four tabs: Record, Display, Network (highlighted in green), and System. Under the Network tab, there is a 'Server' section with three sub-tabs: LAN (highlighted in green), Wi-Fi, and Cellular. The LAN sub-tab is active, showing the following settings:

- Server IP: [Input field]
- Port: 9090
- Server 1: smartvision.paco1.com [On/Off toggle]
- Server 2: [Input field] [Off toggle]
- Server 3: [Input field] [Off toggle]

At the bottom right, there are 'OK' and 'Cancel' buttons.

10.7 File Upload

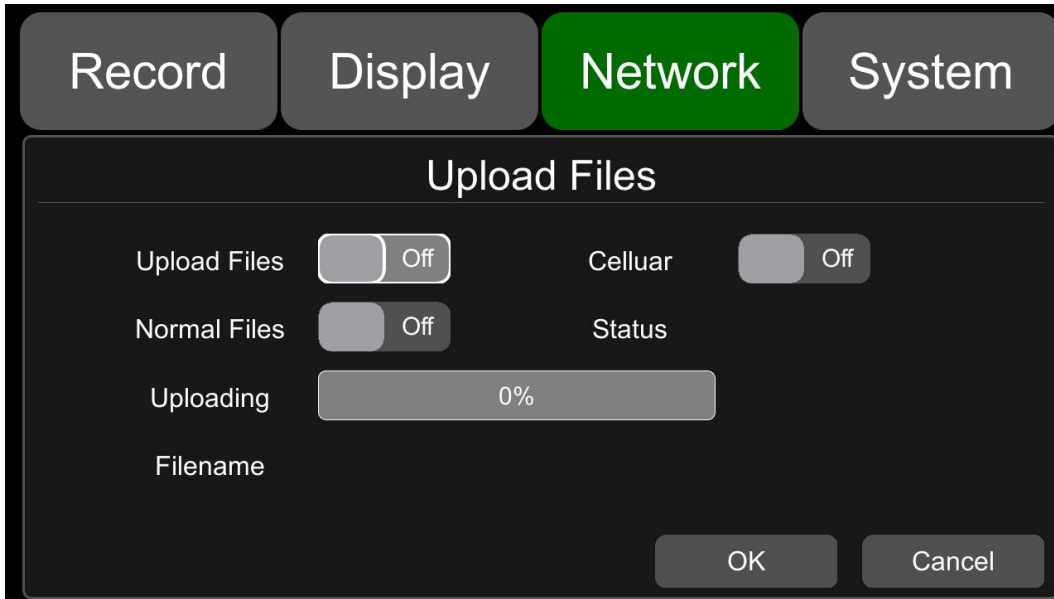

“Upload” default configuration as shown above.

Files : ON/OFF

Normal File : Two states, “OFF” and “ON”.

- OFF : Upload other videos besides normal ones: event recording files, timing recording files
- ON : Upload all video files (Including normal video)

Cellular : Two states, “OFF” and “ON”.

- OFF: When using Cellular to connect to the server, uploading files is not allowed. For example, the following figure shows that the recording file will only be uploaded when using LAN or Wi-Fi to connect to the server. When using Cellular to connect to the server, the recording file will not be uploaded.

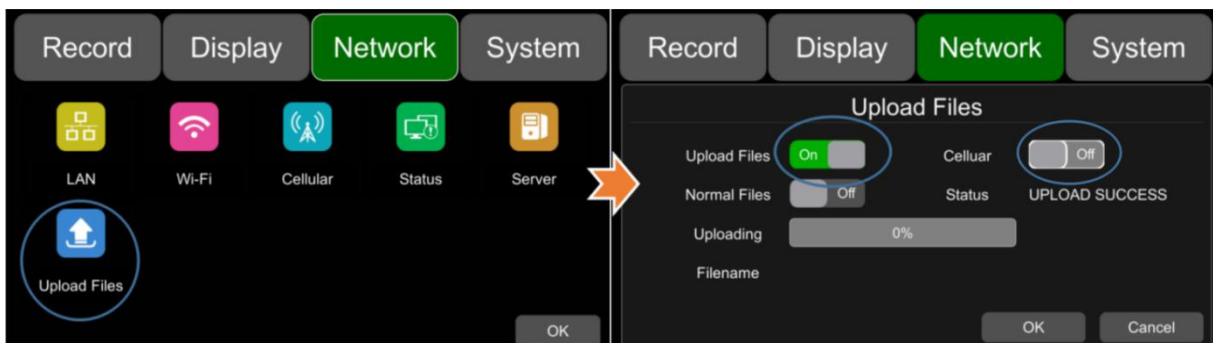

- ON: When using Cellular to connect to the server, uploading files is allowed. When the switch is turned

on, a pop-up box will prompt "Network flow consuming, continue?" Click "OK" to confirm the opening, but after this feature is turned on, once Cellular connects to the server, it will upload the video file, which will consume a lot of cellular flow. So in order to save cellular flow, please set to "OFF".

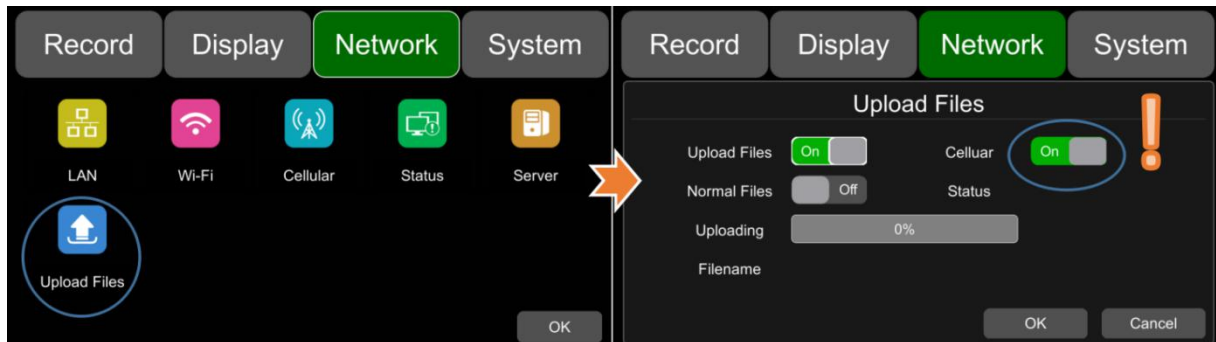

Uploading : Show progress bar of uploaded video file

Filename : Display the file name of the uploaded video file

11 System

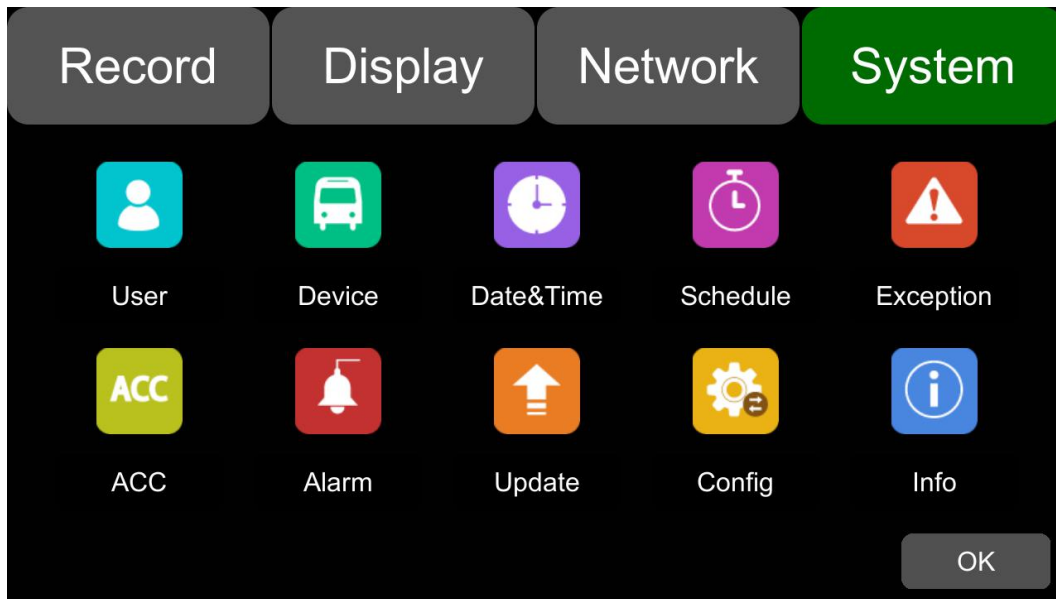

11.1 Log in Setup



Set user name and password for booting up. The initial password is 123.

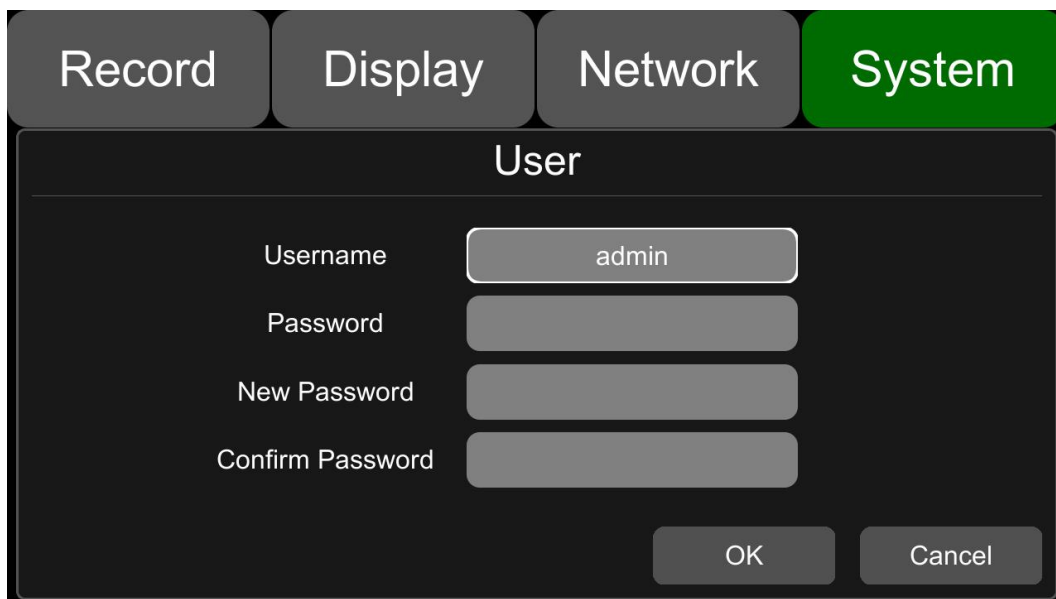

11.2 License Plate Number Setup



Input license plate number. The default configuration is shown below.

Record	Display	Network	System
Device			
License No.	<input type="text" value="AAAAAA"/>		
Device ID	<input type="text" value="1711280010"/>		
		OK	Cancel

11.3 System Time Setup



Format Setup:

Record	Display	Network	System			
Dates&Time						
Date	Year <input type="text" value="2018"/>	Month <input type="text" value="06"/>	Day <input type="text" value="21"/>	1	2	3
Time	Hour <input type="text" value="11"/>	Minute <input type="text" value="17"/>	Second <input type="text" value="38"/>	4	5	6
Format	<input type="text" value="Setup"/>	Time Sync	<input type="text" value="Setup"/>	7	8	9
DST	<input type="text" value="Setup"/>			0	Del	
		OK	Cancel			

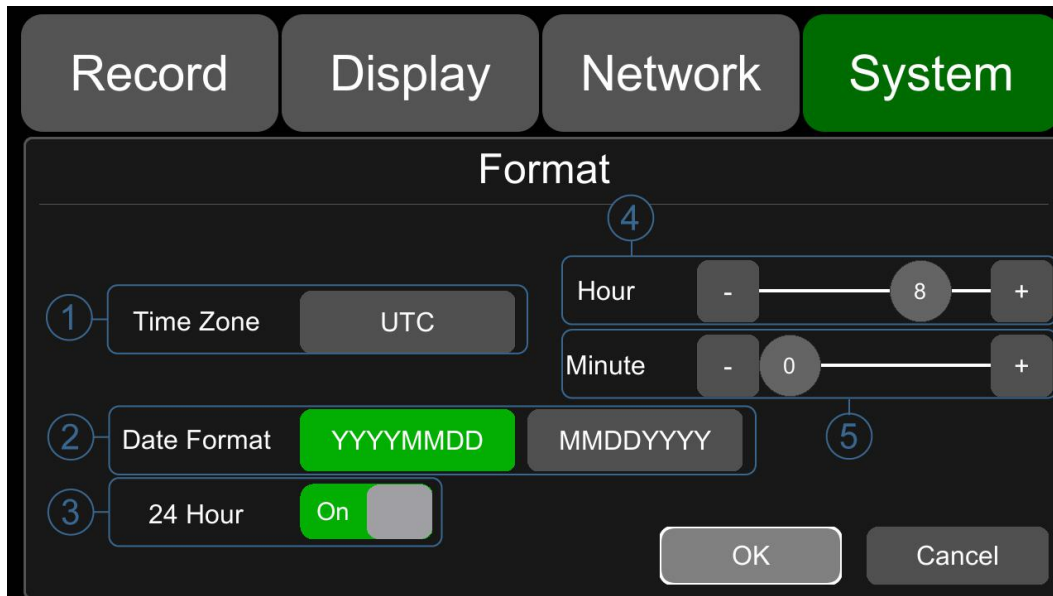

"Format" default configuration as shown above.

Go to "System – Date & Time - Format_Setup" page.

- ① Time Zone: Time zone setting.
- ② Date Format: Set the date of format.
- ③ 24 Hour: If it is ON, time format will be displayed in 24-hour system. If OFF, time format will be displayed in 12-hour system.
- ④ & ⑤ Hour & Minute: Time zone setting accurate to minute.

Time Sync Setup:

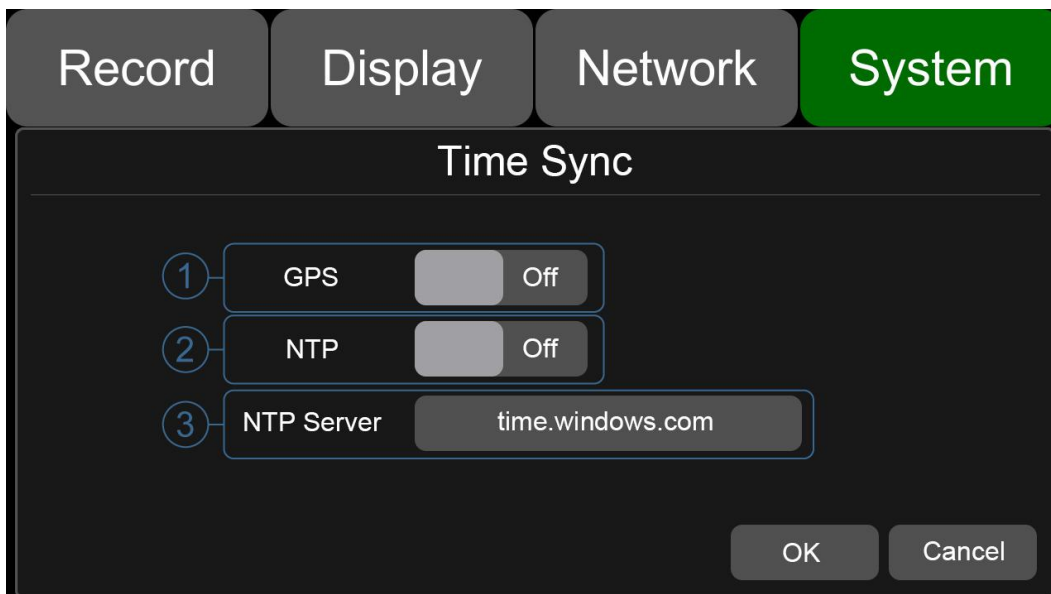

"Time Sync" default configuration as shown above.

Go to "System -> Date & Time -> Time Sync-Setup" page.

- ① GPS: Set GPS to ON/OFF.
- ② NTP: Set NTP to ON/OFF.

③ NTP Server: Show the URL of the NTP Server.

DST Setup:

DST

Enable On

Offset two hour

Mode date

Start Time Month Few Weekday Time

End Time

OK Cancel

“DST” default configuration as shown above.

Go to “System -> Date & Time -> DST-Setup” page.

- ① Enable: Set DST setting to ON/OFF.
- ② Offset: Adjust the offset after enabling DST.
- ③ Mode: Select the mode of DST (setup DST according to week or date).
- ④ Start: Set start time of DST.

End: Set end time of DST.

11.4 Scheduled Recording



Schedule

	Enable	Start	End	Weekday
Schedule 1	<input type="checkbox"/> Off	00:00	01:40	Setup
Schedule 2	<input type="checkbox"/> Off	00:00	01:40	Setup
Schedule 3	<input type="checkbox"/> Off	00:00	01:40	Setup
Schedule 4	<input type="checkbox"/> Off	00:00	01:40	Setup

OK Cancel

The default configuration is shown above.

Enable: Set scheduled recording ON/OFF.

Start: Set start time of scheduled recording.

End: Set end time of scheduled recording.

Week-day: Set scheduled recording by weekdays. Select the weekdays to set preset.

Scheduled Recording:

- Support up to four appointed tasks. The recording duration is counted in minutes.
- Recording time can overlap.
- The start time of scheduled recording must be set ahead of the end time.

11.5 Exception

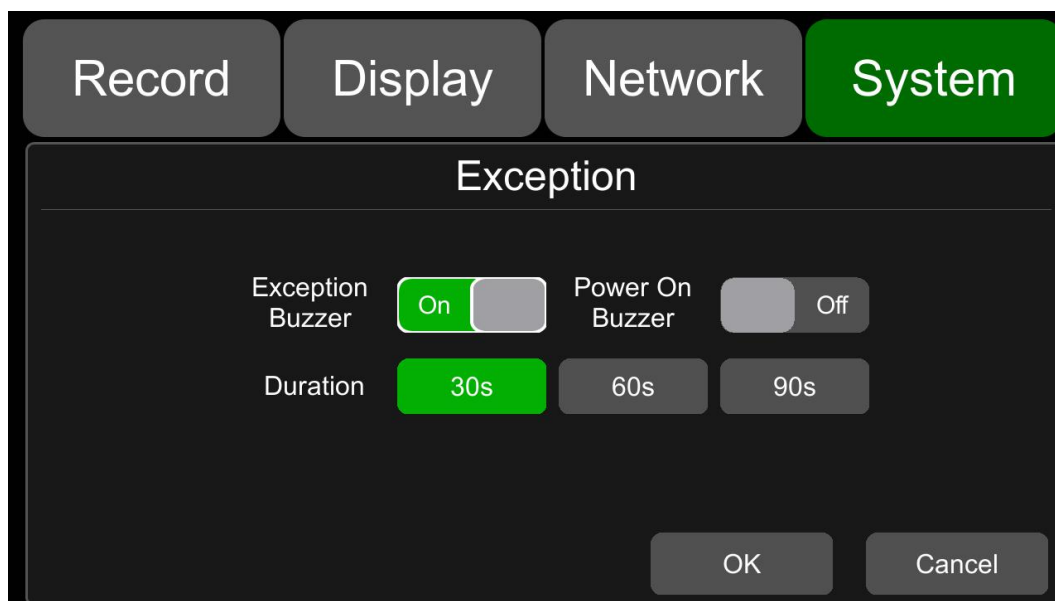

The default configuration is shown above.

Exception Buzzer: Set the exception buzzer to ON/OFF.

Power On Buzzer: Set the power on buzzer to ON/OFF.

Duration: Set the duration time of the buzzer.

11.6 ACC Settings

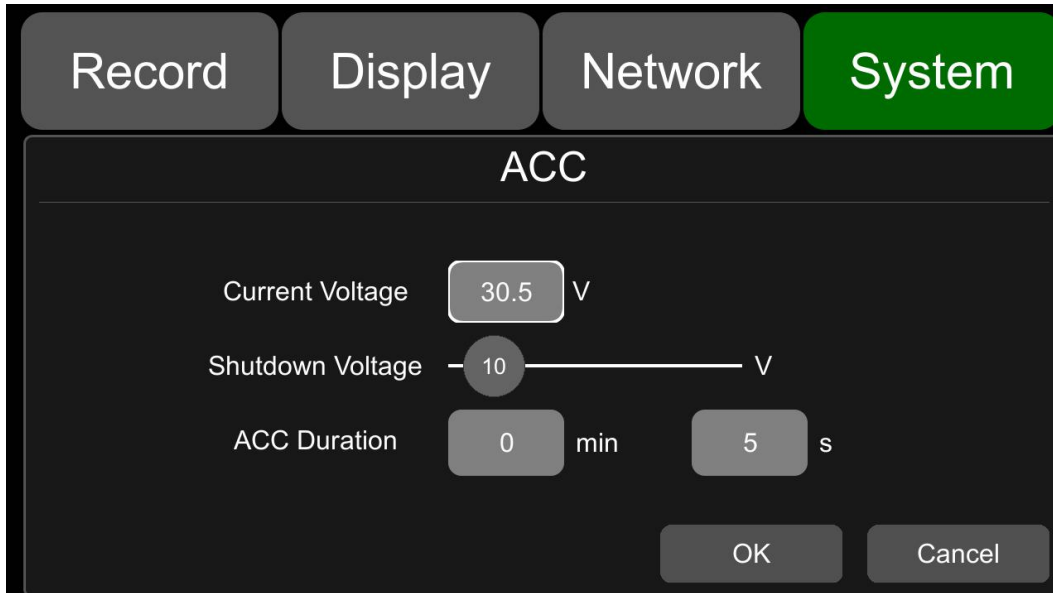

The default configuration of "Shutdown Voltage" and "ACC Duration" is shown above.

Current voltage: Voltage of the working DVR.

Shutdown voltage: When the current or voltage is lower than the shutdown voltage, the device will shut down automatically. When the current or voltage is higher than the shutdown voltage, the device would work properly. When the current or voltage is lower than shutdown voltage and the device is shut down, users could disconnect the VCC of the device for one minute, then the device will come back to work for one minute. During this time users can change the value of shutdown voltage.

ACC Duration: The device will continue recording for a few seconds after ACC is disconnected. ACC delay time can be set to be 5s to 60min.

11.7 Alarm Information Setting

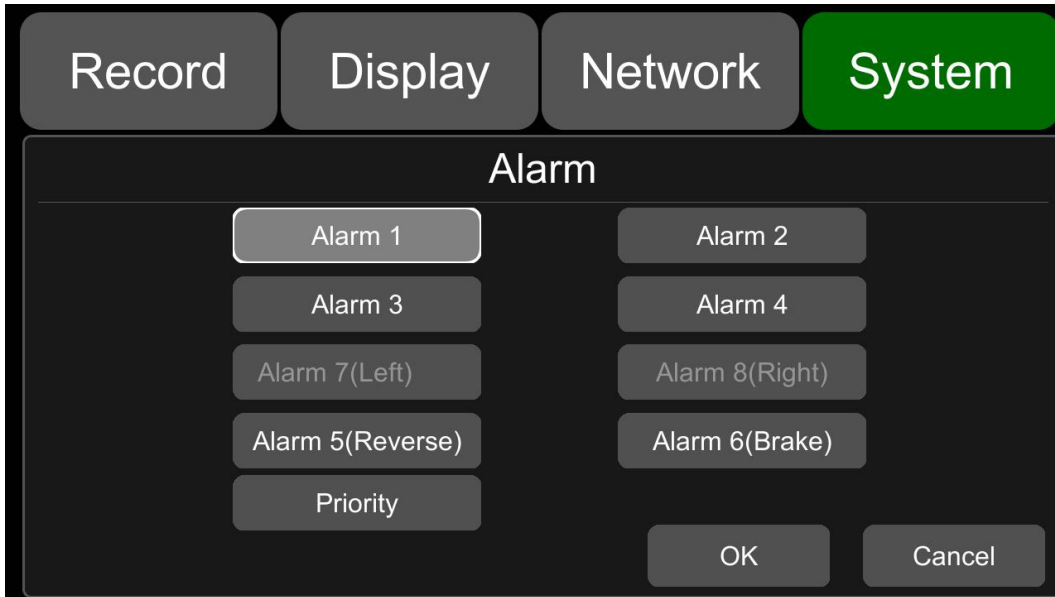

Alarm 1~Alarm 4: Customized alarm recording.

Reverse: Reversing alarm recording. .

Brake: Brake alarm recording.

Priority: Set priorities for Alarm1~Alarm4, Reverse, Brake.

When different types of alarm are triggered at the same time, alarms with the highest priority will work first.

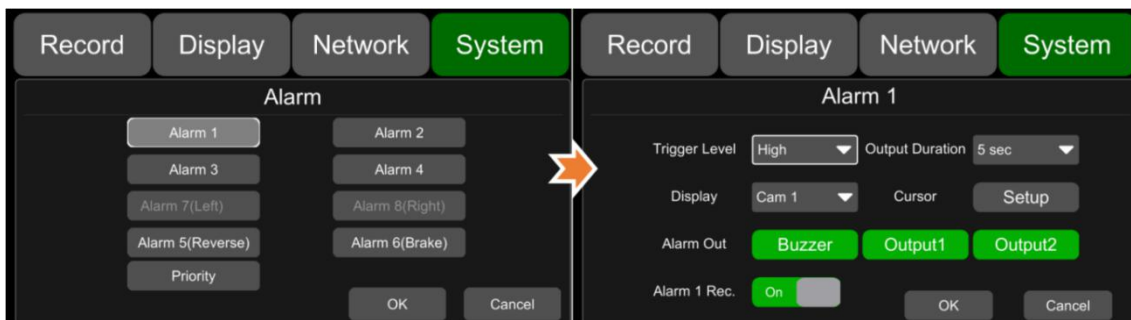

“Alarm 1” default configuration as shown above

Trigger Level: There are 3 options of Trigger Level. The options “Low” and “High” are used for turning on alarm function. “Low” is generally used for debugging while “High” will be selected to turn on alarm function for on-road use. “Off” means turning off alarm trigger function.

Output Duration: "Display" "Cursor" "Alarm Out" effect duration.

Alarm Out-Buzzer: Switch ON or OFF of the Alarm Out-Buzzer. The default buzzer sounds for 5 seconds.

Alarm Out-Output1: Set it ON, then 12V level output would come from the alarm wire of Output 1.

Alarm Out-Output2: Set it ON, then 12V level output would come from the alarm wire of Output 2.

Alarm 1 Rec. : Alarm 1 event recording switch, the recording duration is set in [System]-> [Record]-> [Event Duration]

Display: The selected single channel or dual channels will be in full screen mode once the alarm is triggered.

Cursor : It is "OFF" by default. The picture below shows the open state.

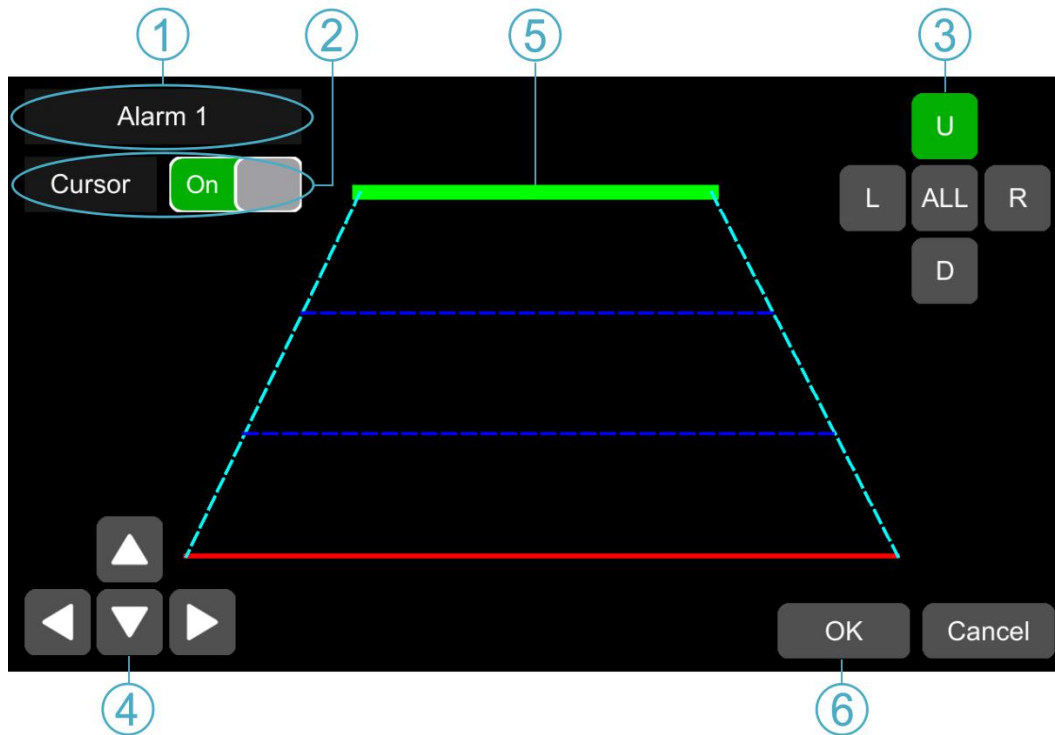

① Camera name of the alarm-triggered channel.

② Touch this button to turn on/off cursor.

③ Line selecting: There are five lines to be selected. Line U (up), Line D (down), Line L (left), Line R (right) and ALL. The button turns green if selected. You can use remote control to operate.

④ There are four directions to adjust the shape of the cursor, Up, Down, Left and Right.

If Line U (the green one) or Line D (the red one) is selected, the selected line can be moved with these directions.

If Line L or Line R is selected, the top point of the selected line can be moved to left or right with Direction Up and Direction Down, and the bottom point of the selected line can be moved to left or right with Direction Left and Direction Right.

⑤ Lines of cursor. The selected one will be thickened for three times. The two lines in the middle will not be processed.

⑤ ⑥ Touch OK to save the settings and exit. Cancel to exit without saving any settings.

Priority : The default configuration is shown below.

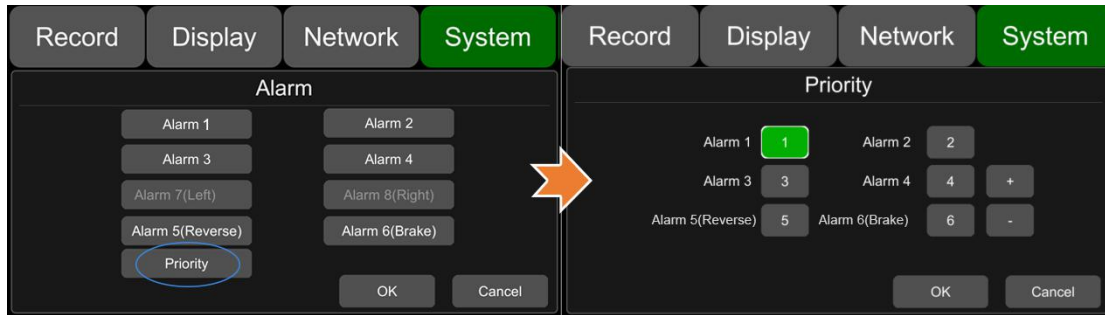

 : Press this button, the priority value of the selected alarm will be added by 1. The bigger the value is, the lower the priority will be.

 : Press this button, the priority value of the selected alarm will be reduced by 1. The smaller the value is, the higher the priority will be.

- Alarms with higher priority will be triggered first.
- 1 is the highest priority, and 8 is the lowest.
- If two alarms A and B are triggered at the same time, and A's priority is higher than B's, then A will record first. After A finishes the recording, if B is still being triggered, B will then record. However, if B is no longer being triggered, it will not record.
- If alarm B is triggered while recording, if alarm A, whose priority is higher than B, is triggered then, B will not stop recording.

11.8 Update



- For single device

Step 1: Copy the folder to USB disk or SD card root directory and insert the USB disk or SD card into the device.

Step 2: Power off the DVR and reboot it, then it will upgrade automatically. Or go to Menu -> System -> Update->Software, touch OK to confirm the upgrading. Both methods can start the upgrade process.

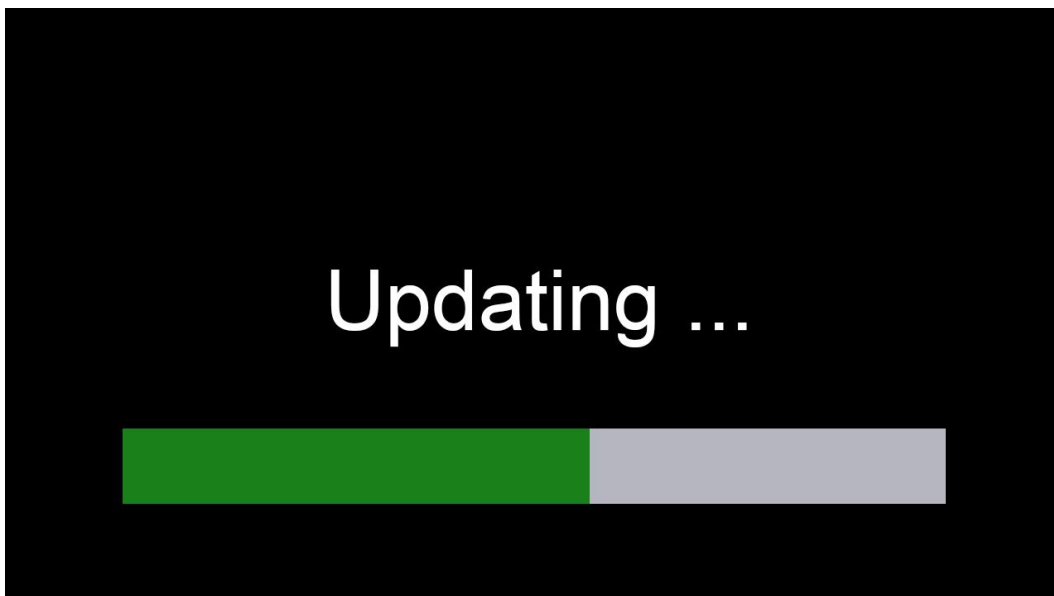
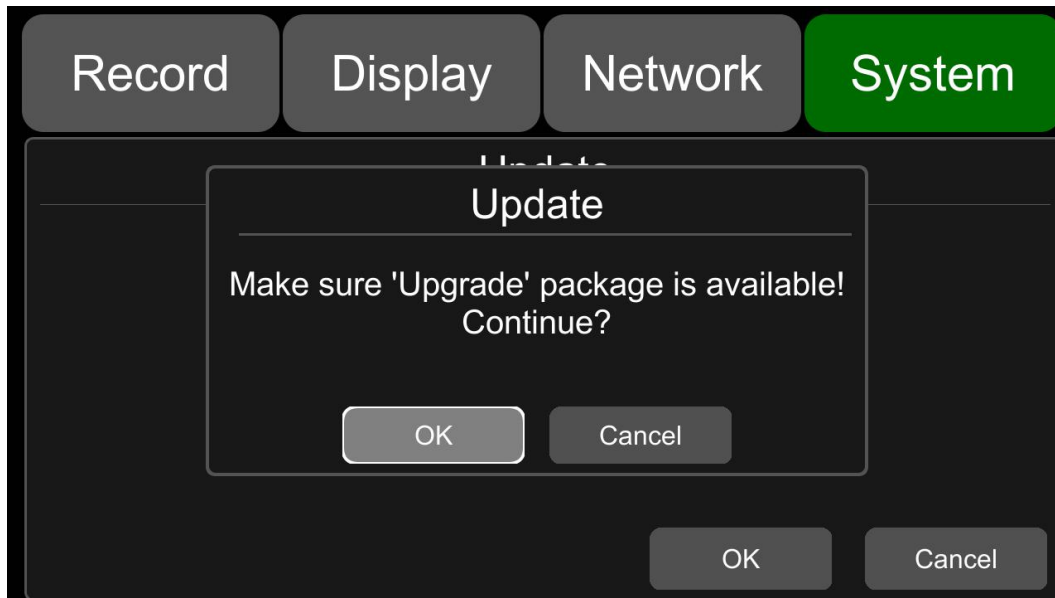

Step 3: When “Update success!” is shown on the display, the device will reboot automatically.

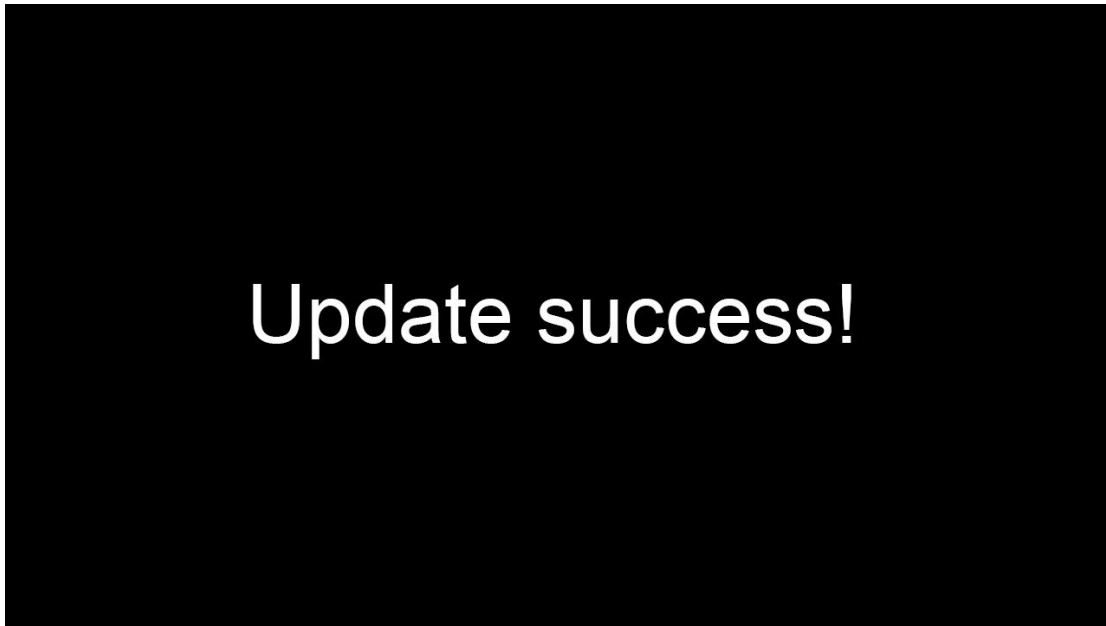

Step 4: After rebooting, please check if the version is the same as the one you copy into “upgrade” folder. Please go to Menu -> System -> Info to check it.

Note: After the upgrade is complete, the "dvxxx_upgrade_201xxxxxxxxx_Rename" upgrade package in the USB disk or SD card will be deleted.

- Remote upgrade

Step 1 : The device connects to server.

Step 2 : Open the Windows client and log in.

Step 3 : Find the license number of the target device in the device list of the client, right click and select “Update” to open the Batch Upgrades interface. If you need to upgrade more than one device, you can click the Add button to select other devices. The selected ones will be displayed on the device list to upgrade. If you want to remove devices from the list, please select them and click the Del button.

Step 4: Select the device to upgrade, and then click the Browser button to select the upgrade package “dvxxx_upgrade_201xxxxxxxxx_Rename”.

Step 5: Click the Start button to upload the upgrade package. When uploading is finished, the device will start upgrading automatically. If it failed to upload, the reason of failure will be displayed in the Remark column in the list.

- Logo upgrade

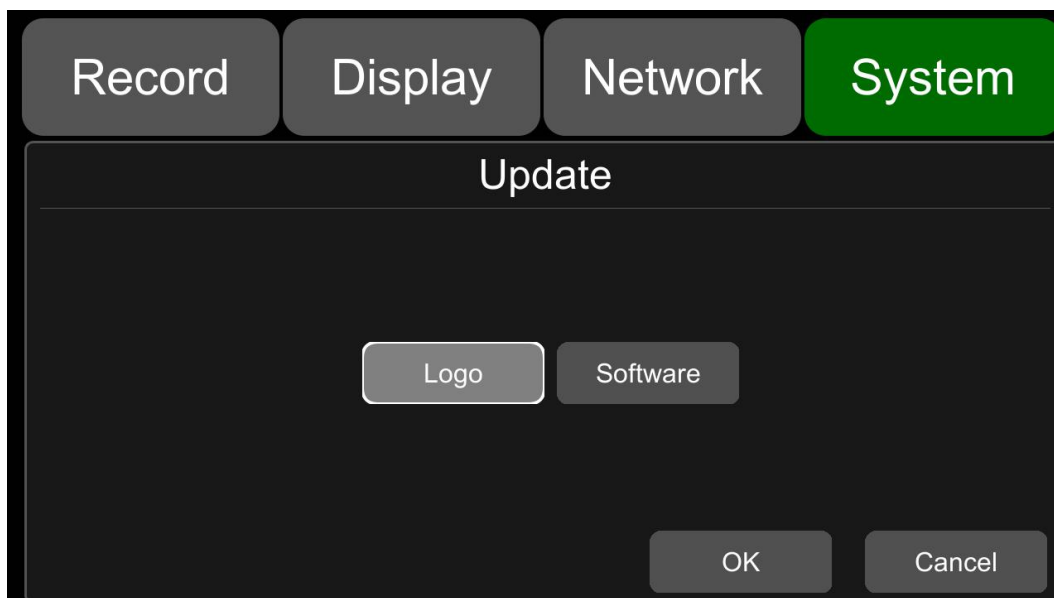

- 1) Put four logo pictures into SD1 card or the root directory of USB flash drive;
- 2) Insert the SD card or the USB flash drive into the DVR device, click System->Update->Logo, and then click OK. Then there will be a prompt message that “start to update the Logo, please wait...”. When the update is finished successfully, a prompt message that “Logo update successfully, restart DVR now? ” will show on the display. Click ok, reboot the device and then the new logo will work.

11.9 Configuration



Configuration Import: Import the configuration information from SSD, SD or USB memory flash devices.

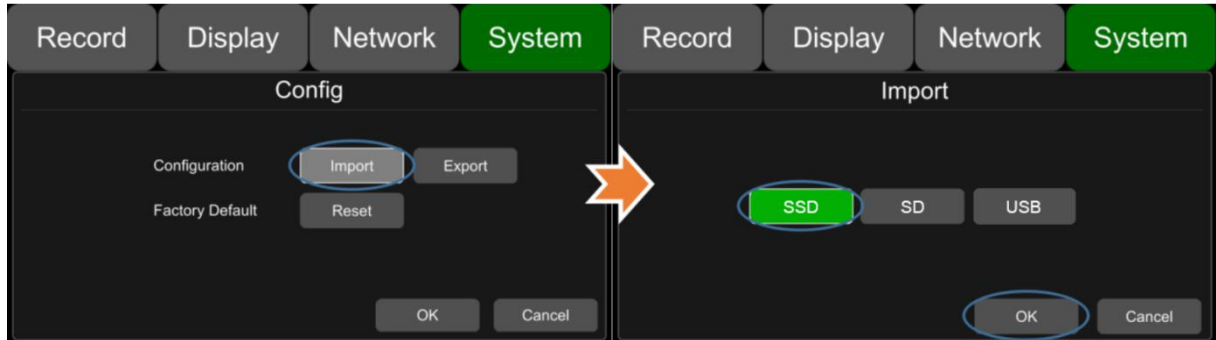

Configuration Export: Export Log to SSD,SD or USB memory flash devices.



Factory Default: Press Reset to restore factory settings.

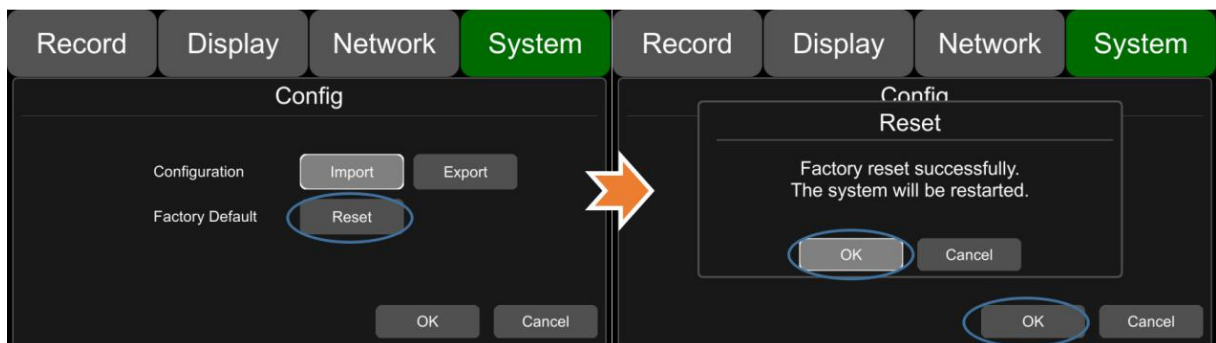

11.10 System Info



System Info : Software version number

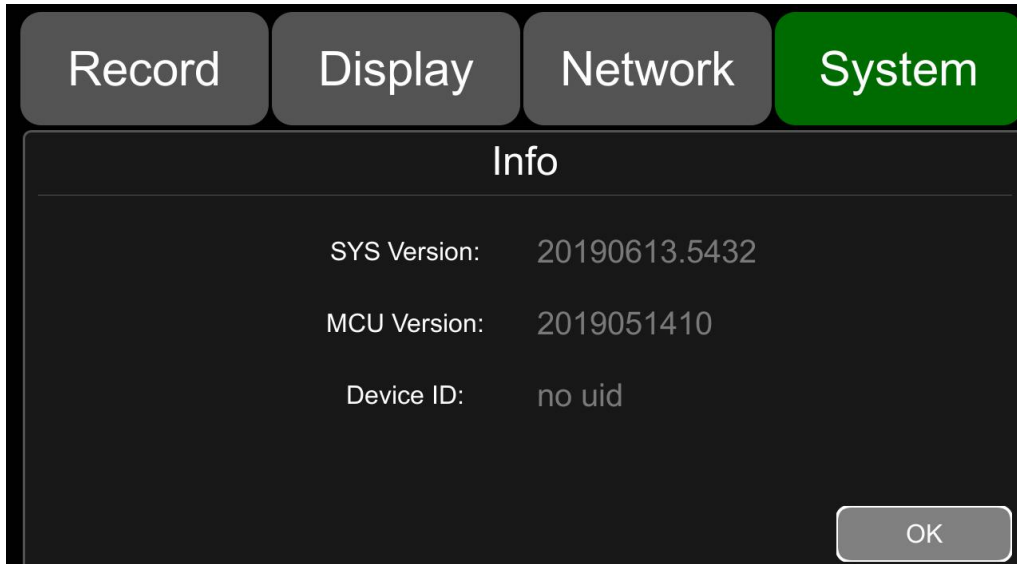

12 FAQ

(1) The System Can't Start up?

Check the power connection. Please follow the steps below to check the power connection:

- ① Check the input power: if the power wire is connected correctly, if the ground wire is connected to the battery, and if the fuse on the power wire is in good condition.
- ② Check if the voltage of the ACC signal wire is higher than 6 V.
- ③ Check if the input voltage of the device is higher than the shutdown voltage set on the screen of the device.

(2) The Device Keeps Restarting?

Please follow the steps below to check:

- ① Check if the supply voltage of DVR is insufficient. If it is lower than the start-up voltage, the device would restart repeatedly.
- ② Restart the device to see if it will work properly.

(3) Unable to Recognize Disks ?

- ① Check if the disk is in good condition and make sure that it is installed with good contact.
- ② The disk has been formatted by DVR.
- ③ Restart the device to see if it will work properly.

(4) Unable to Recognize Cameras ?

- ① Make sure the camera is good and the connection is correct.
- ② Reconnect all wires (e.g. extended wires) between cameras and the device.
- ③ Restart the device to see if it will work properly.

(5) GPS Abnormal ?

Check if the GPS antenna is properly installed.

13 APPENDIX

APPENDIX I : Abbreviation & Description



Rec.	Record	LED	Light Emitting Diode
G-force	Accelerometer Sensor	SD	Secure Digital Memory Card
GPS	Global Positioning System	USB	Universal Serial Bus
Wi-Fi	Wireless-Fidelity	ALM	Alarm
Cam	Camera	VLOSS	Video Loss
AVI	Audio Video Interleaved	COMM	Communication
OSD	On-Screen Display	ERR	Error
APN	Access Point Name	MEM	Memory
DHCP	Dynamic Host Configuration Protocol	MMSHOW	Media Player
SSID	Service Set Identifier	FTP	File Transfer Protocol
IP	Internet Protocol	DVR	Digital Video Recorder
MAC	Media Address Control	IR	Infrared Radiation
RSSI	Received Signal Strength Indication	SYS	System
SSD	Solid State Drive	DST	Daylight Saving Time

APPENDIX II: Accessories

Standard Table:

Accessories	Quantity	Description	Accessories	Quantity	Description
	1	9 PIN Aviation Power Input Wire		1	Remote Control
	1	4CH HD DVR Key		1	Panic Button Conversion Cable
	1	10 PIN Alarm Wire		1	VGA, 10 PIN to 15 PIN Cable
	1	5 PIN CAN BUS Wire		1	7 PIN to RJ45
	1	SSD OUT Conversion Cable			

Optional Accessories Table:

Accessories	Quantity	Description	Accessories	Quantity	Description
	1, Optional	232&485, 8 PIN to 4 PIN Cable		1, Optional	10 Inches HD Monitor
	1, Optional	Four-in-One Antenna (2G-3G-4G-Wi-Fi-GPS)		1, Optional	Panic Button

APPENDIX III: Compatibility Storage List

SATA 3.0 SSD

NAME	Description
SSD 32GB	MLC,TS32GSSD420I,-45°C~85°C
SSD 64GB	MLC,TS64GSSD420I,-45°C~85°C
SSD 128GB	MLC,TS128GSSD420I,-45°C~85°C
SSD 256GB	MLC,TS256GSSD420I,-45°C~85°C
SSD 512GB	MLC,TS512GSSD420I,-45°C~85°C
SSD 1TB	MLC,TS1TSSD420I,-45°C~85°C
SSD 128GB	3D TLC,TS128GSSD450K,0°C~70°C
SSD 256GB	3D TLC,TS256GSSD450K,0°C~70°C
SSD 512GB	3D TLC,TS512GSSD450K,0°C~70°C
SSD 1TB	3D TLC,TS1TSSD450K,0°C~70°C

SD Card

NAME	Description
32GB SD Card	32G, MLC,NCSXDAB-032G,Longsys,-25°C~85°C
64GB SD Card	64G, MLC,NCSXJAB-064G ,Longsys,-25°C~85°C
128GB SD Card	128G, MLC,NCSXJAB-128G ,Longsys,-25°C~85°C
64GB micro SD Card	64G,MLC,NCIXJBB-064G